

**REQUEST FOR INFORMATION (RFI)
36C25018B0688**

PROJECT NUMBER:	610-303	Please ensure that before submitting questions or requests for clarification that you thoroughly read the solicitation, specifications, drawings and other pertinent documents. When submitting questions on this project the Government requires contractors to specifically identify the specification and/or solicitation section(s) or drawing number(s) in reference to the question or request for clarification submitted. No question or request for clarification will be answered by the Government unless the above requirements are met. Failure to comply may prevent the Government from responding in a timely manner.
PROJECT TITLE:	Building Primary Care Clinic (PACT)	
PROJECT LOCATION:	Department of Veterans Affairs VA Northern Indiana HCS 1700 E. 38 th Street Marion, IN 46953	

SUBMITTED BY:	Armcorp Construction Inc	CITY/STATE:	Celina, OH
PHONE:	419-778-7024		

TO:
 Felecia Beamen, Contracting Officer
 Department of Veterans Affairs
 Network 10 Contracting Office
 8888 Keystone Crossing, Suite 1100
 Indianapolis, IN 46240
Felecia.Beamen@va.gov

RFI NO.: N/A	DATE: 8/20/2018	SPEC/DWG. REFERENCE(s): N/A
REPLY NEEDED BY:		

INFORMATION NEEDED:

Can photos of the existing signs be provided?

REPLY:

Attached are the sign renderings utilized from the previous signage project. Signs are VA provided and VA installed. The attached is for reference only.

REPLY FROM: Jacob Morrival	DATE: 8/23/2018
ATTACHMENTS: Exterior & Interior Sign Renderings	COPY TO:

Replacement Faces for

Type EI-01.02

Internally Illuminated, Masonry Monument - Existing
Mechanically Fasten using Existing Mounting Method

QTY: 4

All Message Layouts as specified
in VA Signage Design Guide 2012

takeform

11601 Maple Ridge Rd, Medina, NY, 14103
P 800.528.1398 F 585.798.8889
www.takeform.net

Signify
EXTERIOR SIGNAGE

Project:
Marion IN VAMC
Campus Updates - Exterior

Date: 02.08.16
Drawn By: JB

Filename:
DEP0005_143436_EXT_Rev6

Revisions:

04.01.16	JB
06.21.16	JB
07.21.16	JB
08.10.16	JB
08.25.16	JB
09.01.16	JB

Signify 01

Scale:
1/2" = 1'-0"

Notes:

Verify existing conditions and panel Trim Size prior to fabrication.

Product Approval

NO CHANGES	
Approved By:	Date:
WITH CHANGES AS NOTED	
Approved By:	Date:

Product will be manufactured as indicated on this document. Please review carefully.



Panel

Painted Routed .125 Aluminum
Font: Customer Supplied Artwork
to match **PMS 541 C** VA Blue

Illuminated Copy

3/16" Translucent Acrylic Backer
7328 White

Type EN-03.02
 S01PP-CUSTOM
 Double Sided Post and Panel
 Panel Count: Side A (1), Side B (1)
 Direct Bury
 36" Minimum Post Embedment
QTY: 4

All Message Layouts as specified
 in VA Signage Design Guide 2012

takeform

11601 Maple Ridge Rd, Medina, NY, 14103
 P 800.528.1398 F 585.798.8889
 www.takeform.net

Signify
 EXTERIOR SIGNAGE

Project:
 Marion IN VAMC
 Campus Updates - Exterior

Date: 02.08.16
 Drawn By: JB

Filename:
 DEP0005_143436_EXT_Rev6

Revisions:
 04.01.16 JB
 06.21.16 JB
 07.21.16 JB
 08.10.16 JB
 08.25.16 JB
 09.01.16 JB

Signify 01

Scale:
 1/2" = 1'-0"

Notes:

EX-OV-N024

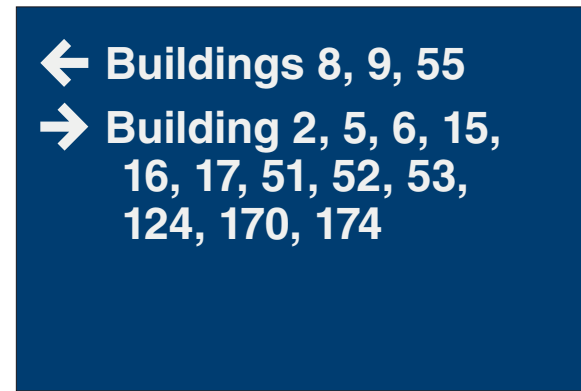

Side A

EX-OV-N029

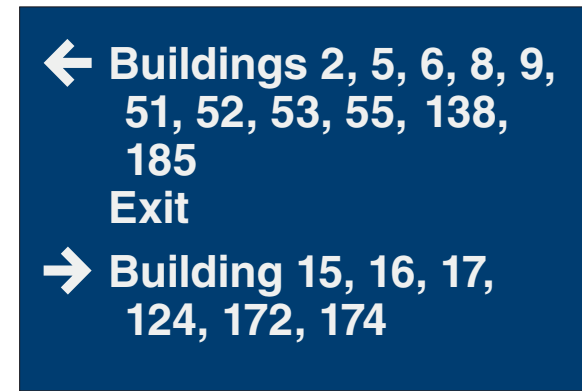

Side A

EX-OV-N030

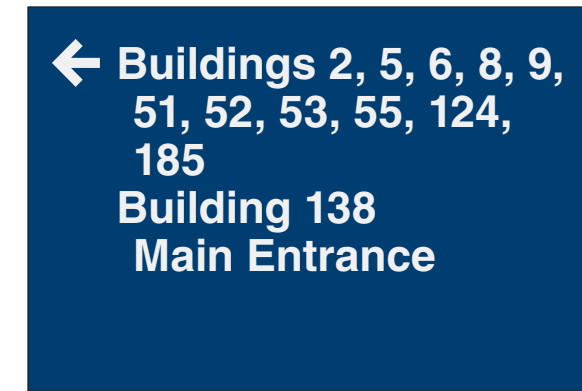

Side A



Plan View

EX-01-R028

Message Layout A

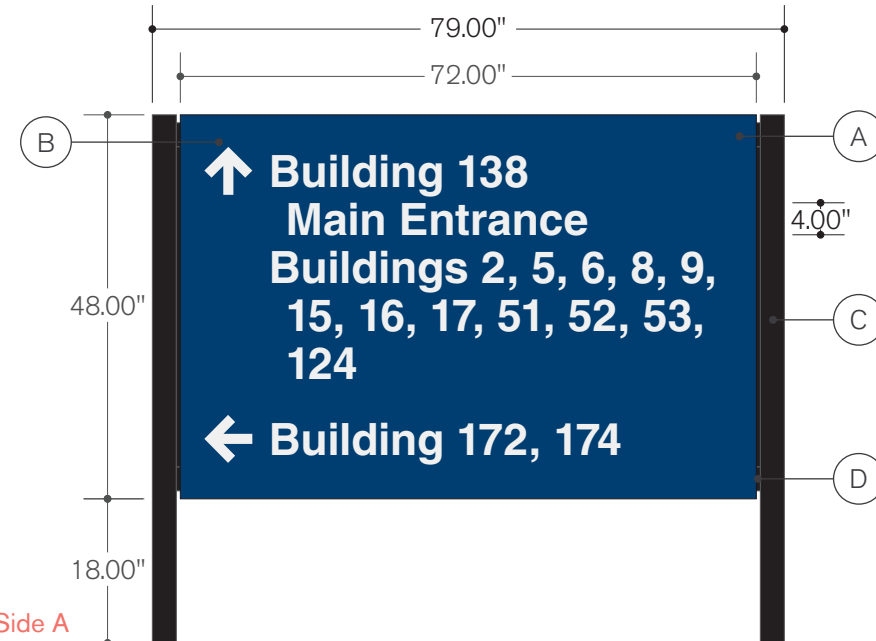

Side A



Profile

Painted
 1" Aluminum
 Angle Filler

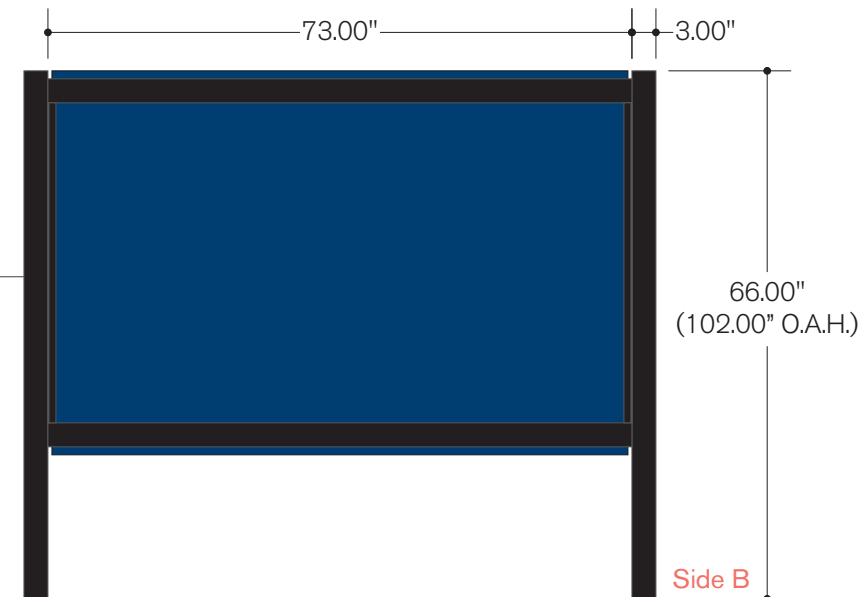

Side B

Panel

(A) Painted .125 Aluminum to match **PMS 541 C** VA Blue

Copy

(B) First Surface Applied Vinyl
 Font: Customer Supplied Artwork / Helvetica Bold
280-10 White Reflective

Post

(C) Painted 3" X 6" Aluminum Rectangular Tube
CO101 Black

Cross Arm

(D) Painted 3" X 6" Aluminum Rectangular Tube
CO101 Black

Product Approval

NO CHANGES
Approved By:
Date:
WITH CHANGES AS NOTED
Approved By:
Date:

Product will be manufactured as indicated on this document. Please review carefully.

Type EN-03.04
 S01PP-CUSTOM
 Single Sided Post and Panel
 Panel Count: Side A (1)
 Direct Bury
 36" Minimum Post Embedment
QTY: 25

All Message Layouts as specified
 in VA Signage Design Guide 2012

takeform

11601 Maple Ridge Rd, Medina, NY, 14103
 P 800.528.1398 F 585.798.8889
 www.takeform.net

Signify
 EXTERIOR SIGNAGE

Project:
 Marion IN VAMC
 Campus Updates - Exterior

Date: 02.08.16
 Drawn By: JB

Filename:
 DEP0005_143436_EXT_Rev6

Revisions:

04.01.16	JB
06.21.16	JB
07.21.16	JB
08.10.16	JB
08.25.16	JB
09.01.16	JB

Signify 01

Scale:
 1" = 1'-0"

Notes:



Plan View

EX-01-N019 Message Layout C

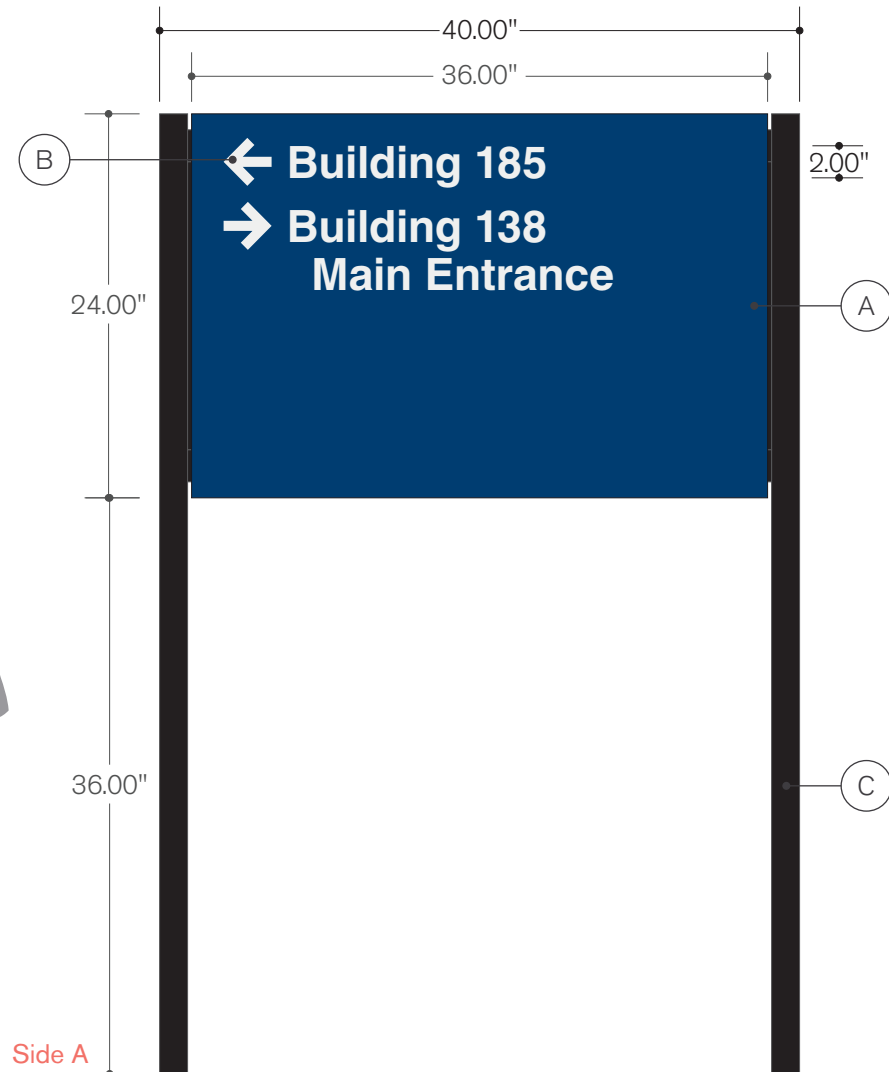

Profile

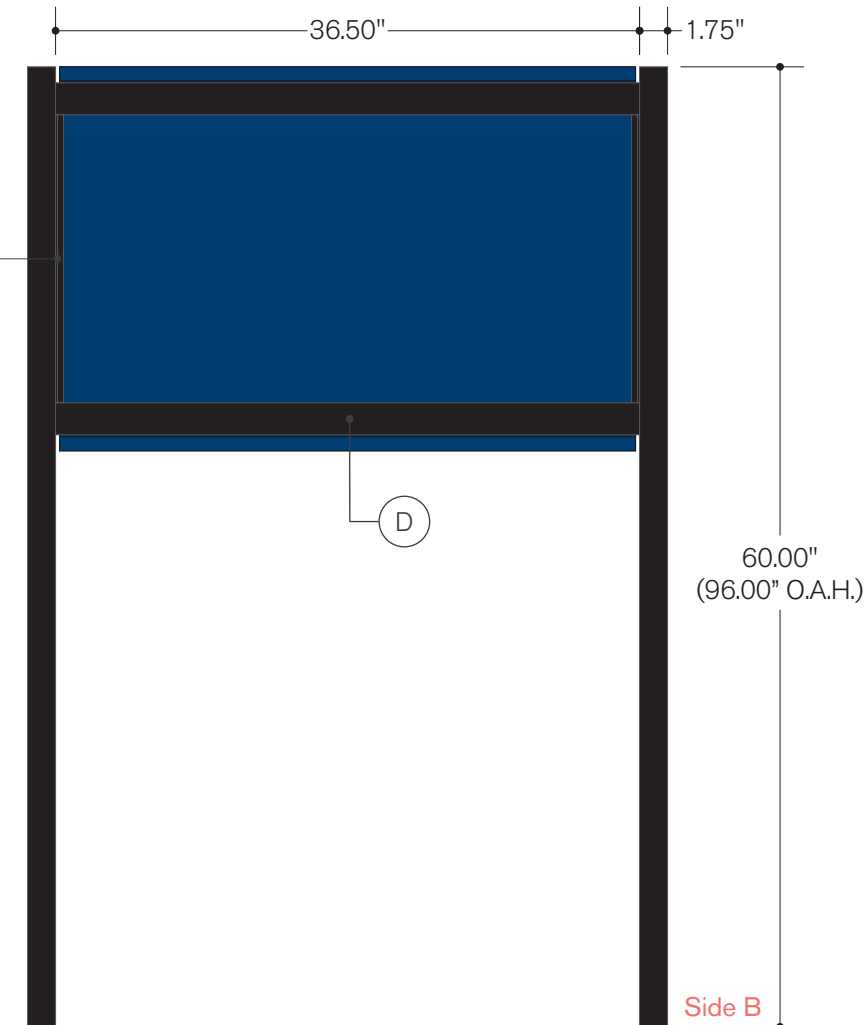

Side B

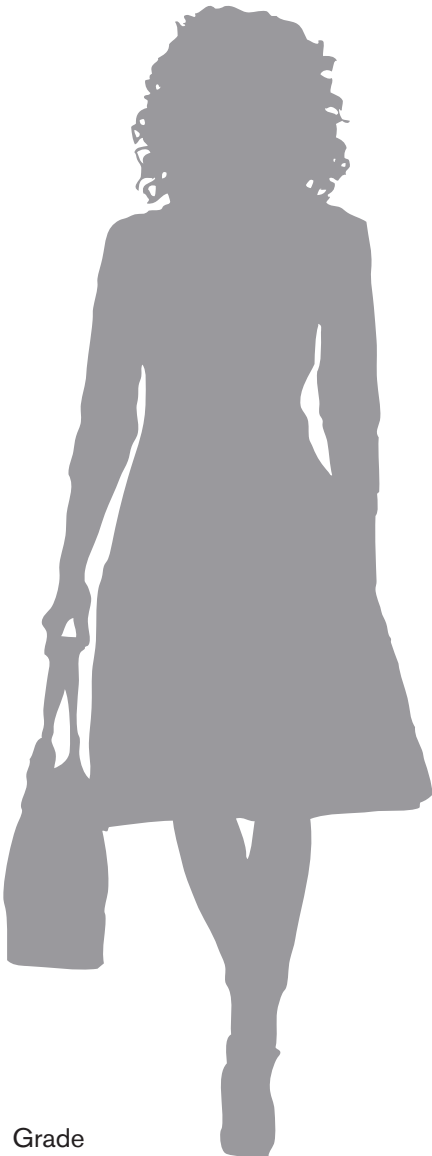

Grade

Side A

Panel

(A) Painted .125 Aluminum to match **PMS 541 C** VA Blue

Copy

(B) First Surface Applied Vinyl
 Font: Customer Supplied Artwork / Helvetica Bold
280-10 White Reflective

Post

(C) Painted 1 3/4" X 3" Aluminum Rectangular Tube
CO101 Black

Cross Arm

(D) Painted 2" Aluminum Square Tube
CO101 Black

Product Approval

NO CHANGES
Approved By:
Date:
WITH CHANGES AS NOTED
Approved By:
Date:

Product will be manufactured as indicated on this document. Please review carefully.

EX-01-R016

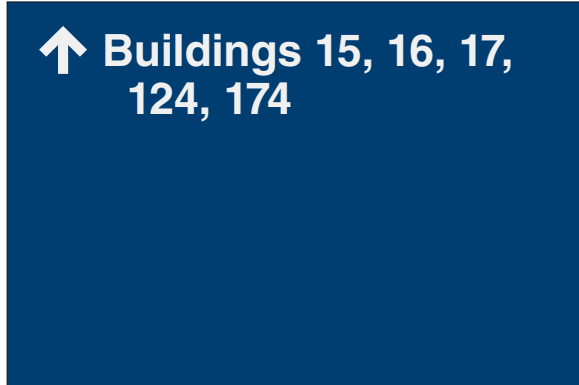

EX-01-R106



EX-02-R010, EX-OV-N012



EX-04-R001

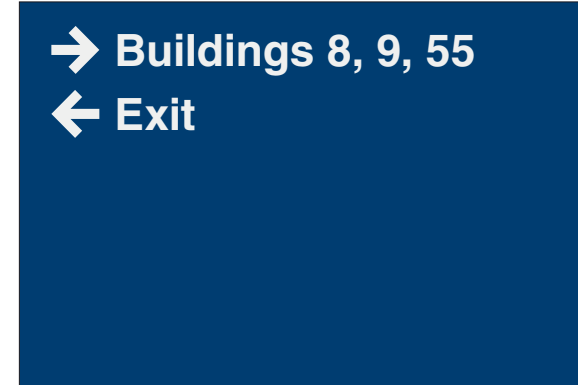

EX-04-R002

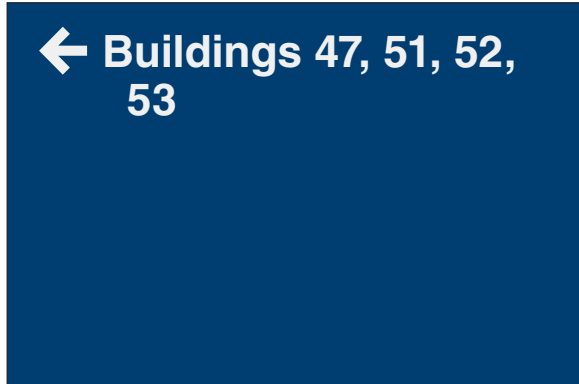

EX-OV-N005

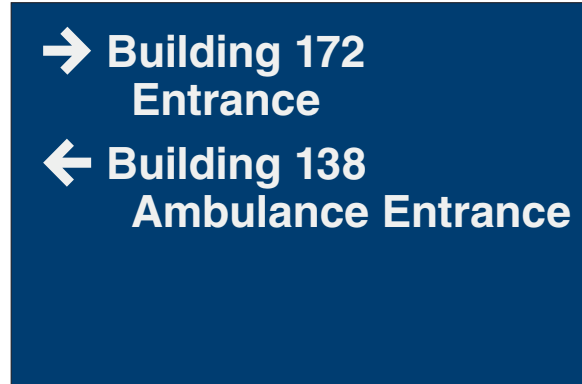

QTY: 2

EX-OV-N009

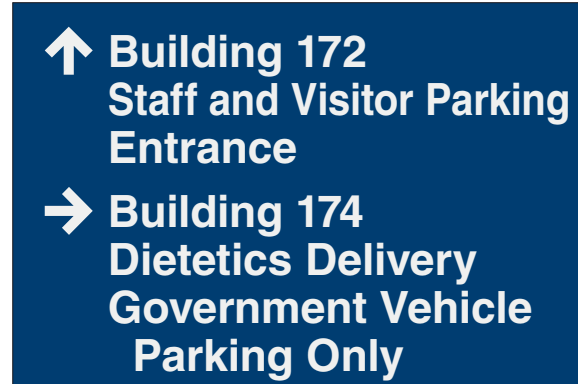

EX-OV-N015

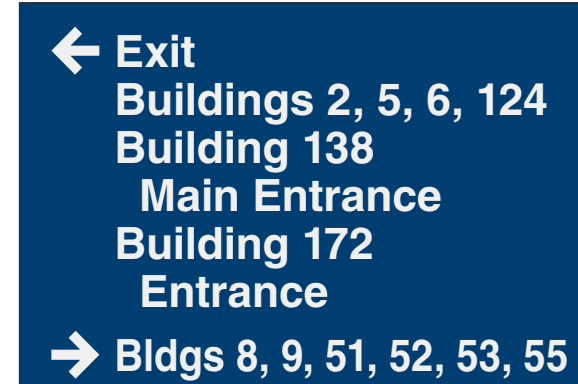

EX-OV-N016

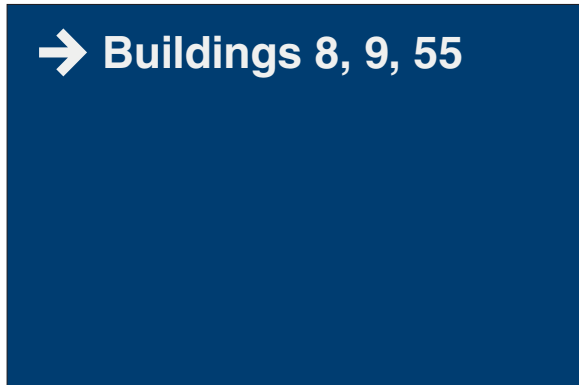

EX-OV-N017, EX-OV-N018,
EX-OV-N023, EX-OV-N031

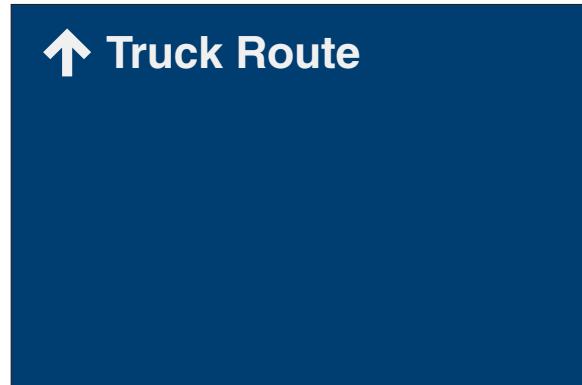

EX-OV-N019

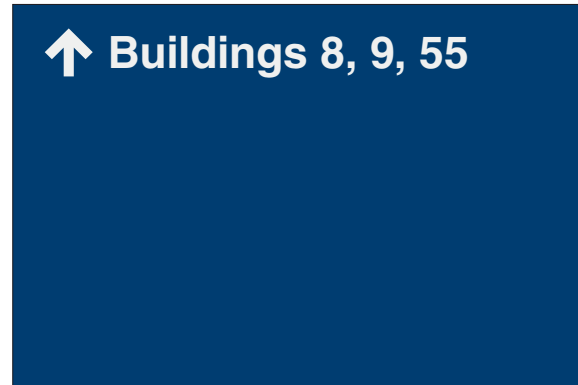

EX-OV-N021

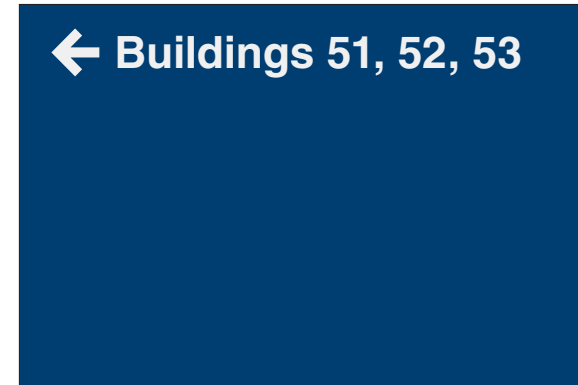

EX-OV-N022

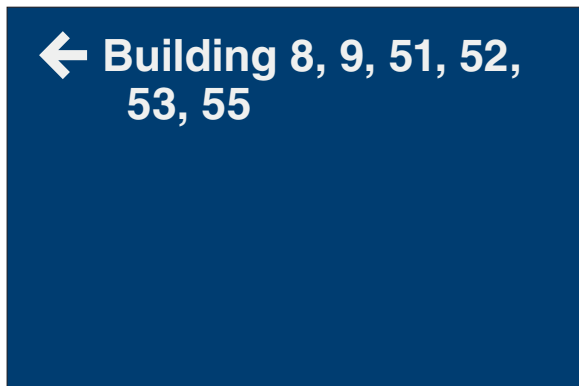

QTY: 4

EX-OV-N032

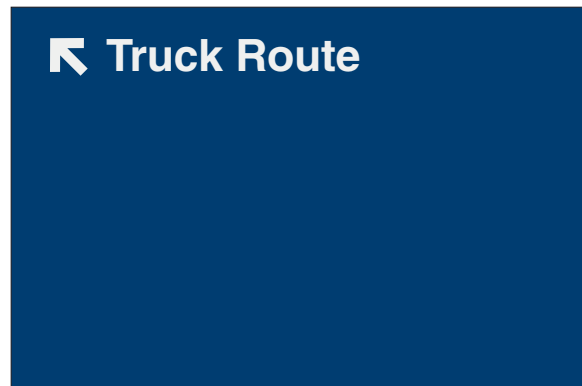

EX-OV-N002

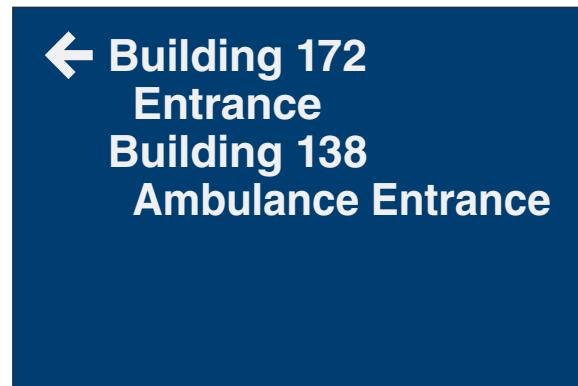

EX-OV-N001



Project:
Marion IN VAMC
Campus Updates - Exterior

Date: 02.08.16
Drawn By: JB

Filename:
DEP0005_143436_EXT_Rev6

Revisions:

04.01.16	JB
06.21.16	JB
07.21.16	JB
08.10.16	JB
08.25.16	JB
09.01.16	JB

Signify 01

Scale:
1" = 1'-0"

Notes:
Refer to page 3 of 22 for
fabrication details

Product Approval

NO CHANGES	
Approved By:	Date:
WITH CHANGES AS NOTED	
Approved By:	Date:

Product will be manufactured as indicated on this document. Please review carefully.

Project:
Marion IN VAMC
Campus Updates - Exterior

Date: 02.08.16
Drawn By: JB

Filename:
DEP0005_143436_EXT_Rev6

Revisions:

04.01.16	JB
06.21.16	JB
07.21.16	JB
08.10.16	JB
08.25.16	JB
09.01.16	JB

Signify 01

Scale:
1" = 1'-0"

Notes:
Refer to page 3 of 22 for
fabrication details

Product Approval

NO CHANGES	
Approved By:	
Date:	
WITH CHANGES AS NOTED	
Approved By:	
Date:	

Product will be manufactured as indicated on this document. Please review carefully.

EX-OV-N008

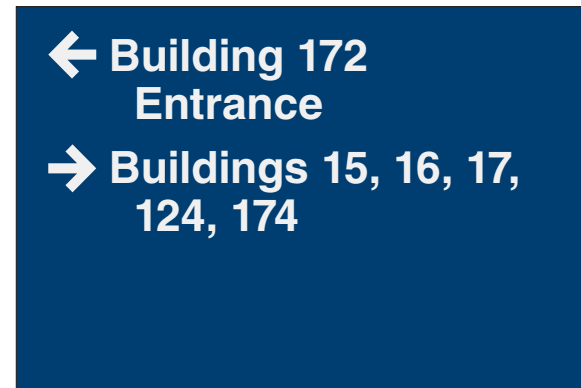

EX-OV-N025

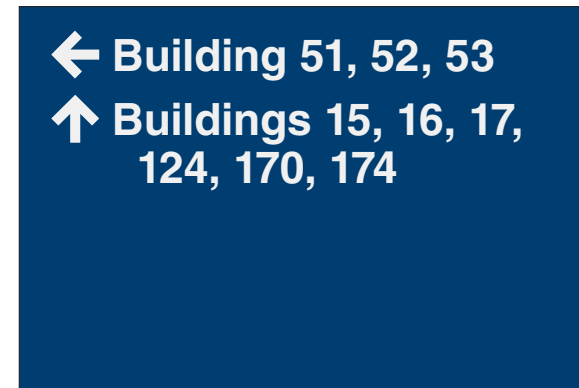

EX-OV-N026

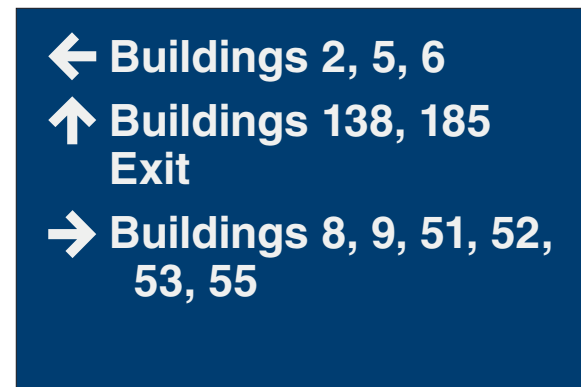

EX-OV-N027

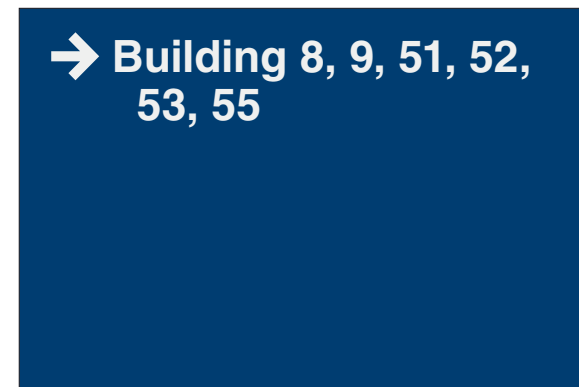

Type EN-03.04.a
 S01PP-CUSTOM
 Double Sided Post and Panel
 Panel Count: Side A (1), Side B (1)
 Direct Bury
 36" Minimum Post Embedment
QTY: 1

All Message Layouts as specified
 in VA Signage Design Guide 2012

takeform

11601 Maple Ridge Rd, Medina, NY, 14103
 P 800.528.1398 F 585.798.8889
 www.takeform.net

Signify
 EXTERIOR SIGNAGE

Project:
 Marion IN VAMC
 Campus Updates - Exterior

Date: 02.08.16
 Drawn By: JB

Filename:
 DEP0005_143436_EXT_Rev6

Revisions:

04.01.16	JB
06.21.16	JB
07.21.16	JB
08.10.16	JB
08.25.16	JB
09.01.16	JB

Signify 01

Scale:
 1" = 1'-0"

Notes:

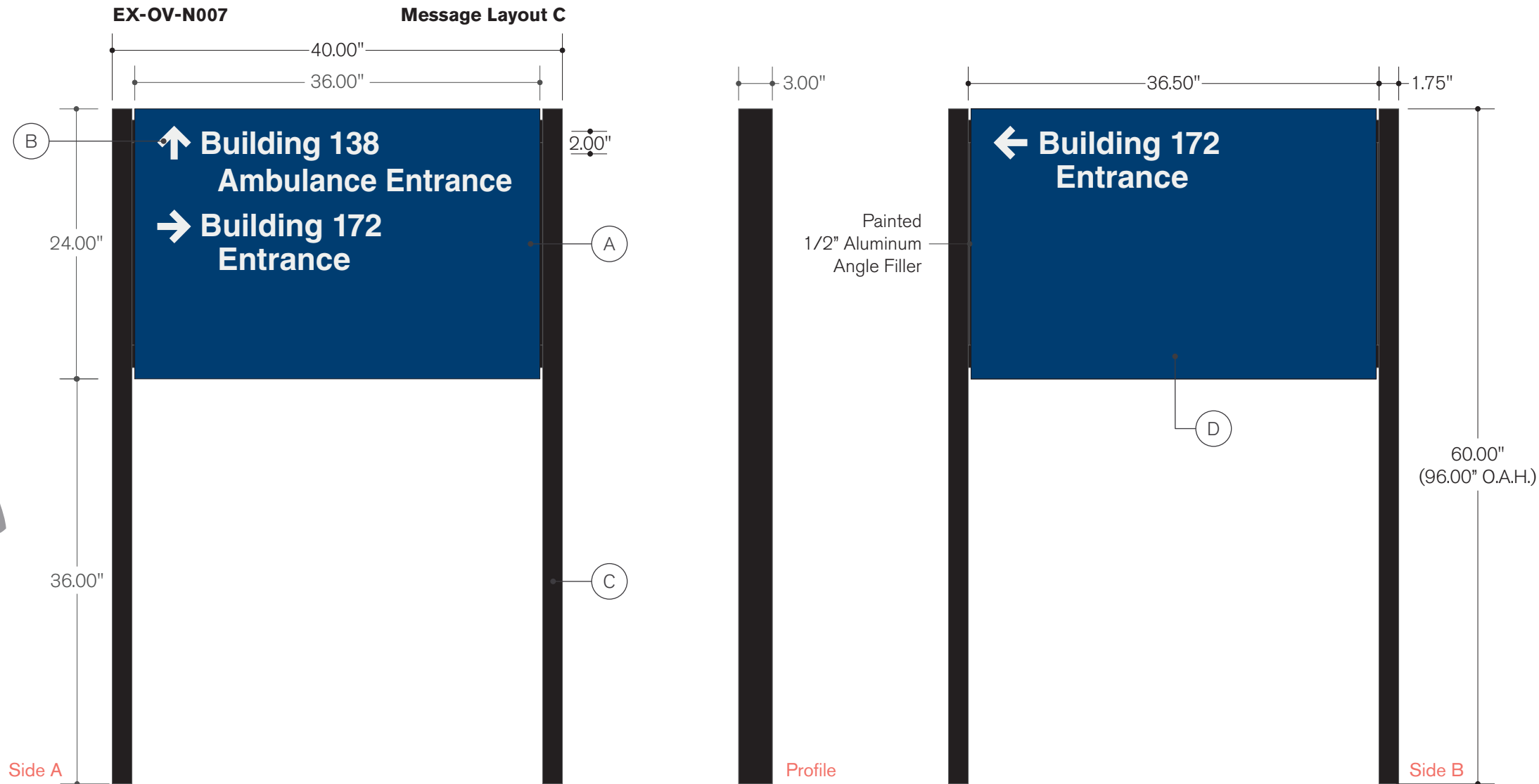

Panel

(A) Painted .125 Aluminum to match **PMS 541 C** VA Blue

Copy

(B) First Surface Applied Vinyl
 Font: Customer Supplied Artwork / Helvetica Bold
280-10 White Reflective

Post

(C) Painted 1 3/4" X 3" Aluminum Rectangular Tube
CO101 Black

Cross Arm

(D) Painted 2" Aluminum Square Tube
CO101 Black

Product Approval

NO CHANGES
Approved By: _____
Date: _____
WITH CHANGES AS NOTED
Approved By: _____
Date: _____

Product will be manufactured as indicated on this document. Please review carefully.

Type EN-03.06
 S01PP-24-24
 Single Sided Post and Panel
 Panel Count: Side A (1)
 Direct Bury
 36" Minimum Post Embedment
QTY: 23

All Message Layouts as specified
 in VA Signage Design Guide 2012

takeform

11601 Maple Ridge Rd, Medina, NY, 14103
 P 800.528.1398 F 585.798.8889
 www.takeform.net

Signify
 EXTERIOR SIGNAGE

Project:
 Marion IN VAMC
 Campus Updates - Exterior

Date: 02.08.16
 Drawn By: JB

Filename:
 DEP0005_143436_EXT_Rev6

Revisions:

04.01.16	JB
06.21.16	JB
07.21.16	JB
08.10.16	JB
08.25.16	JB
09.01.16	JB

Signify 01

Scale:
 1" = 1'-0"

Notes:



Plan View

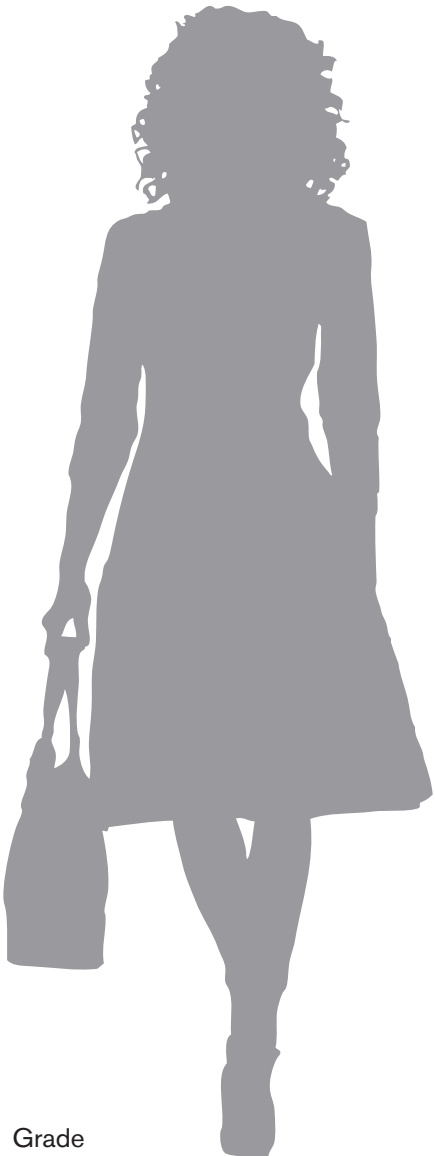
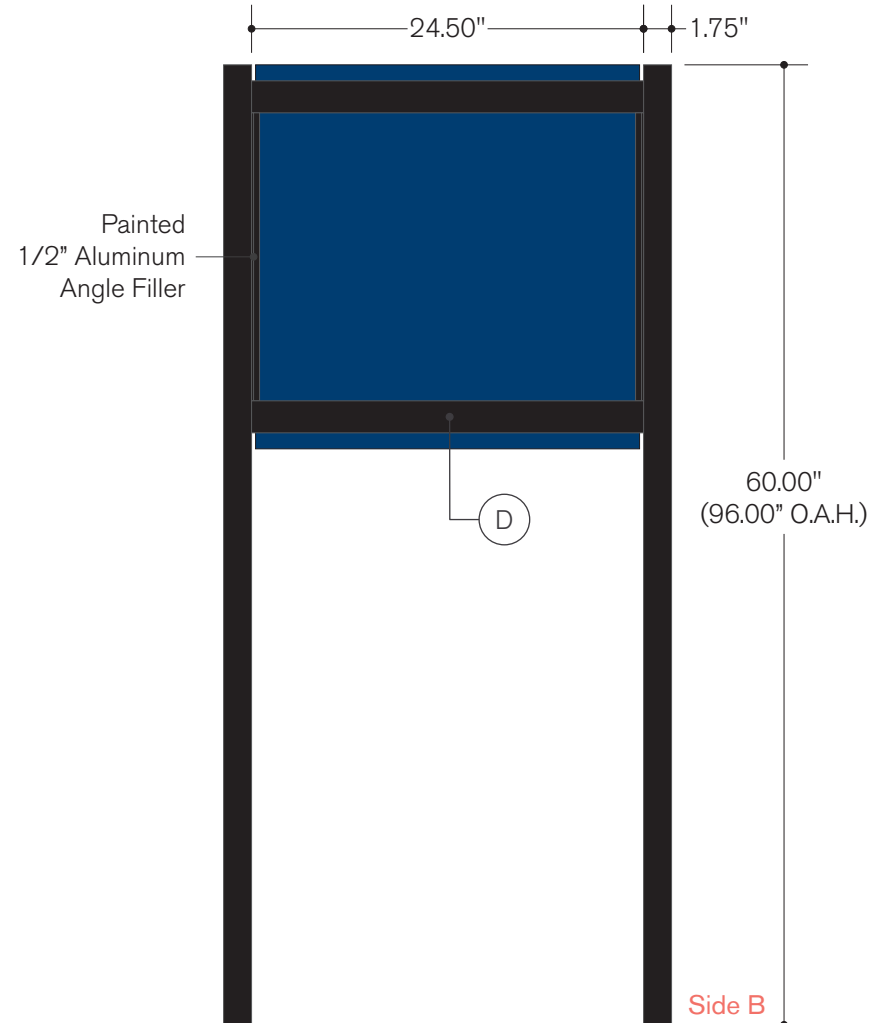
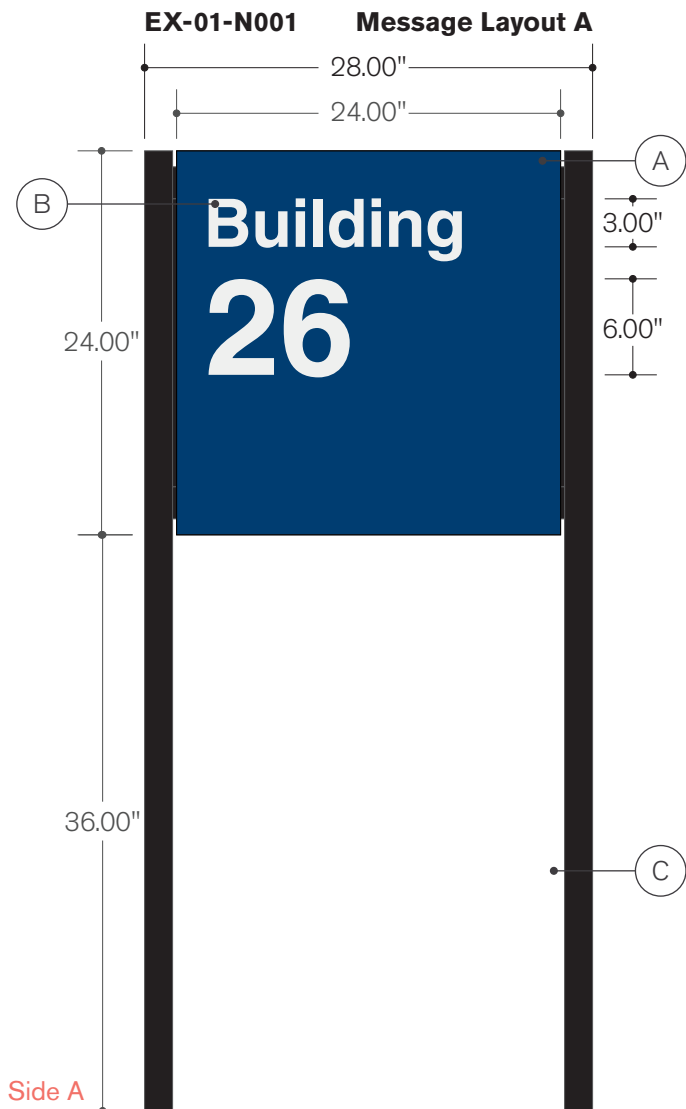

Grade

Side A

Profile

Side B

Panel

(A) Painted .125 Aluminum to match **PMS 541 C** VA Blue

Copy

(B) First Surface Applied Vinyl
 Font: Customer Supplied Artwork / Helvetica Bold
280-10 White Reflective

Post

(C) Painted 1 3/4" X 3" Aluminum Rectangular Tube
CO101 Black

Cross Arm

(D) Painted 2" Aluminum Square Tube
CO101 Black

Product Approval

NO CHANGES
Approved By: _____
Date: _____
WITH CHANGES AS NOTED
Approved By: _____
Date: _____

Product will be manufactured as indicated on this document. Please review carefully.

Project:
 Marion IN VAMC
 Campus Updates - Exterior

Date: 02.08.16 Drawn By: JB

Filename:
 DEP0005_143436_EXT_Rev6

Revisions:

04.01.16	JB
06.21.16	JB
07.21.16	JB
08.10.16	JB
08.25.16	JB
09.01.16	JB

Signify 01

Scale:
 3/4" = 1'-0"

Notes:
 Refer to page 7 of 22 for
 fabrication details

Product Approval

NO CHANGES
Approved By:
Date:
WITH CHANGES AS NOTED
Approved By:
Date:

Product will be manufactured as indicated
 on this document. Please review carefully.

EX-00-R059

Building
175
 Electric
 Service

Message Layout B

EX-01-N002

Building
27

EX-01-N003

Building
28

EX-01-N004

Building
29

EX-01-N005

Building
30

EX-01-N006

Building
31

EX-01-R033

Building
174
 Dietetics

EX-01-R043

Building
172

EX-02-R004

**Police Office
 and
 Information
 Center**

EX-04-N005

Building
137

EX-04-R003

Building
49

EX-04-R027
EX-04-R028

Building
55
 Warehouse

QTY: 2

EX-05-N002

Building
1

EX-05-N011

Building
79

EX-05-R022

Building
2

EX-05-R034

Building
3

EX-05-R048

Building
4

EX-05-R061

Building
5

EX-05-R076

Building
6

EX-05-R080

Building
173
 Grounds
 Crew

EX-05-R084

Building
47
 Theater

2.00"

Type EN-04.01
 S01PP-96-48
 Double Sided Post and Panel
 Panel Count: Side A (1), Side B (1)
 Direct Bury
 36" Minimum Post Embedment
QTY: 3

EX-OV-N014

→ **Building 138**
Main Entrance
ADA Parking
Building 185

← **Building 8, 55**

↑ **Buildings 2, 5, 6, 15, 16, 17, 51, 52, 53, 124, 170**

Side A

EX-OV-N028

← **Buildings 15, 16, 17, 124**

↑ **Buildings 2, 5, 6, 8, 9, 51, 52, 53, 124, 170, 185**
Building 138
Main Entrance

Side A

All Message Layouts as specified
 in VA Signage Design Guide 2012

takeform

11601 Maple Ridge Rd, Medina, NY, 14103
 P 800.528.1398 F 585.798.8889
 www.takeform.net

Signify
 EXTERIOR SIGNAGE

Project:
 Marion IN VAMC
 Campus Updates - Exterior

Date: 02.08.16
 Drawn By: JB

Filename:
 DEP0005_143436_EXT_Rev6

Revisions:

04.01.16	JB
06.21.16	JB
07.21.16	JB
08.10.16	JB
08.25.16	JB
09.01.16	JB

Signify 01

Scale:
 1/2" = 1'-0"

Notes:

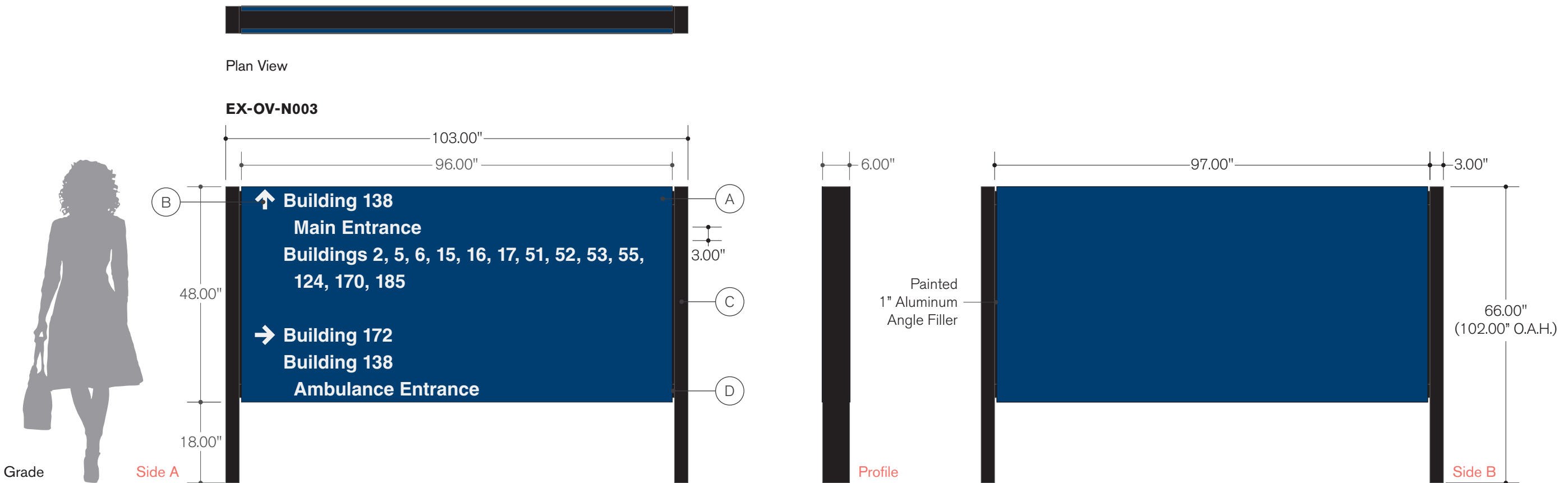

Panel

(A) Painted .125 Aluminum to match **PMS 541 C** VA Blue

Copy

(B) First Surface Applied Vinyl
 Font: Customer Supplied Artwork / Helvetica Bold
280-10 White Reflective

Post

(C) Painted 3" X 6" Aluminum Rectangular Tube
CO101 Black

Cross Arm

(D) Painted 3" X 6" Aluminum Rectangular Tube
CO101 Black

Product Approval

NO CHANGES	
Approved By:	Date:
WITH CHANGES AS NOTED	
Approved By:	Date:

Product will be manufactured as indicated on this document. Please review carefully.

Type EN-05.02
 S01PP-18-24
 Single Sided Post and Panel
 Panel Count: Side A (1)
 Direct Bury
 36" Minimum Post Embedment

QTY: 2

All Message Layouts as specified
 in VA Signage Design Guide 2012

takeform

11601 Maple Ridge Rd, Medina, NY, 14103
 P 800.528.1398 F 585.798.8889
 www.takeform.net

Signify
 EXTERIOR SIGNAGE

Project:
 Marion IN VAMC
 Campus Updates - Exterior

Date: 02.08.16
 Drawn By: JB

Filename:
 DEP0005_143436_EXT_Rev6

Revisions:

04.01.16	JB
06.21.16	JB
07.21.16	JB
08.10.16	JB
08.25.16	JB
09.01.16	JB

Signify 01

Scale:
 1" = 1'-0"

Notes:

Product Approval

NO CHANGES	
Approved By:	Date:
WITH CHANGES AS NOTED	
Approved By:	Date:

Product will be manufactured as indicated on this document. Please review carefully.

EX-02-R014

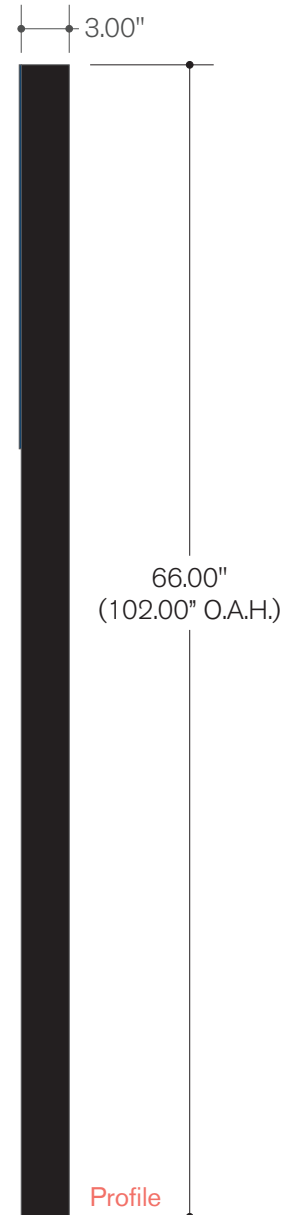
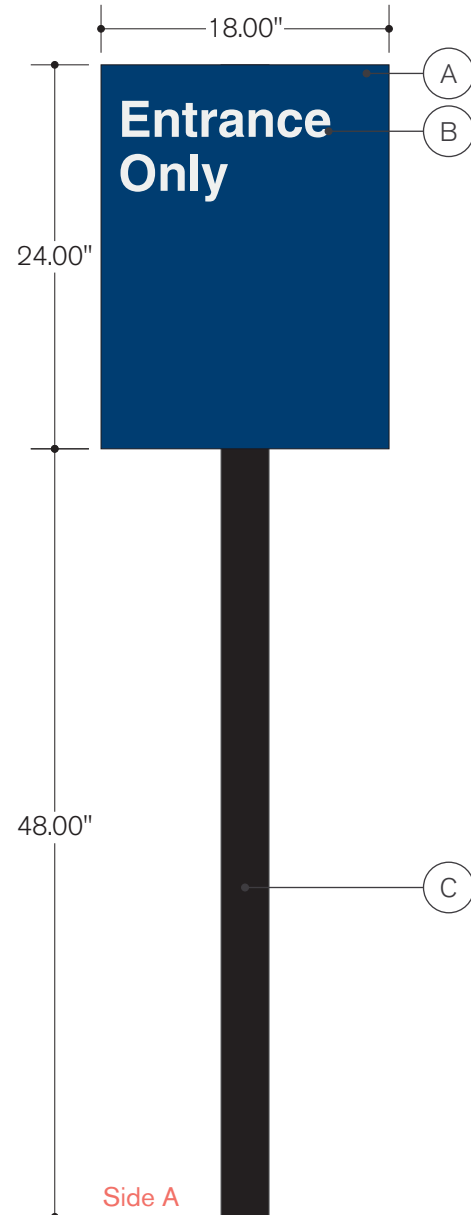

EX-02-R015



Message Layout A

Panel

(A) Painted .125 Aluminum
CO104 White / to match **PMS 541 C** VA Blue

Copy

(B) First Surface Applied Vinyl
 Font: Customer Supplied Artwork / Helvetica Bold
220-10 White

Post

(C) Painted 3" Aluminum Square Tube
CO101 Black

Type IN-02.11
 S01PP-24-30 CUSTOM
 Single Sided Post and Panel
 Panel Count: Side A (1)
 Direct Bury
 36" Minimum Post Embedment
QTY: 2

All Message Layouts as specified
 in VA Signage Design Guide 2012

takeform

11601 Maple Ridge Rd, Medina, NY, 14103
 P 800.528.1398 F 585.798.8889
 www.takeform.net

Signify
 EXTERIOR SIGNAGE

Project:
 Marion IN VAMC
 Campus Updates - Exterior

Date: 02.08.16
 Drawn By: JB

Filename:
 DEP0005_143436_EXT_Rev6

Revisions:

04.01.16	JB
06.21.16	JB
07.21.16	JB
08.10.16	JB
08.25.16	JB
09.01.16	JB

Signify 01

Scale:
 1" = 1'-0"

Notes:

Refer to Customer Approved
 message schedule for final
 copy.

Product Approval

NO CHANGES	
Approved By:	Date:
WITH CHANGES AS NOTED	
Approved By:	Date:

Product will be manufactured as indicated
 on this document. Please review carefully.

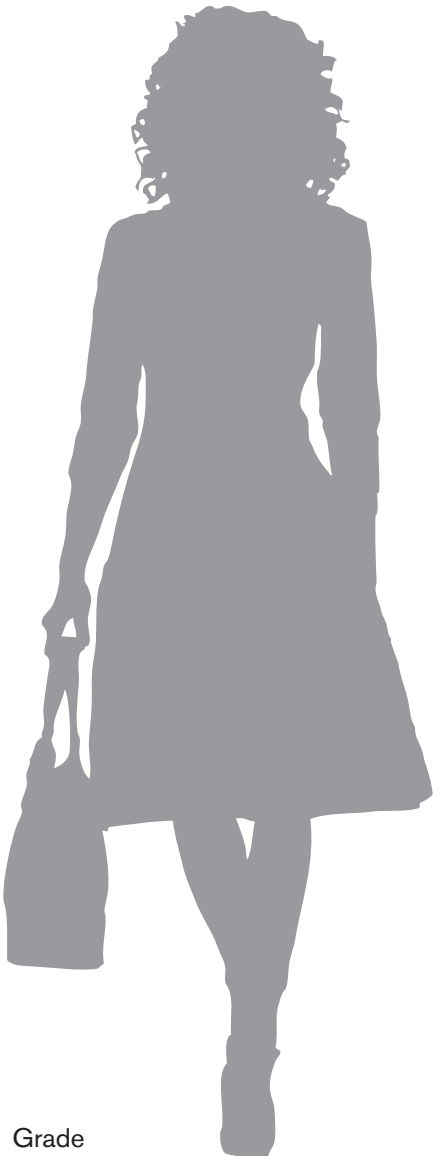

Message Layout: English Version

Panel

(A) Painted .125 Aluminum
CO104 White

Copy

(B) First Surface Applied Vinyl
 Font: Customer Supplied Artwork
220-47 Intense Blue / **220-53** Cardinal Red / **220-12** Black

Post

(C) Painted 3" Aluminum Square Tube
CO101 Black

Type IN-02.12
 S01PP-18-24
 Single Sided Post and Panel
 Panel Count: Side A (1)
 Direct Bury
 36" Minimum Post Embedment
QTY: 35

EX-01-R004, EX-01-R040, EX-01-R048, EX-01-R067, EX-01-R070, EX-01-R076, EX-05-N015, EX-05-R001, EX-05-R006, EX-05-R008, EX-05-R013, EX-05-R017, EX-05-R019, EX-05-R021, EX-05-R024, EX-05-R029, EX-05-R031, EX-05-R033, EX-05-R038, EX-05-R043, EX-05-R045, EX-05-R047, EX-05-R051, EX-05-R056, EX-05-R059, EX-05-R060, EX-05-R064, EX-05-R069, EX-05-R073, EX-05-R075

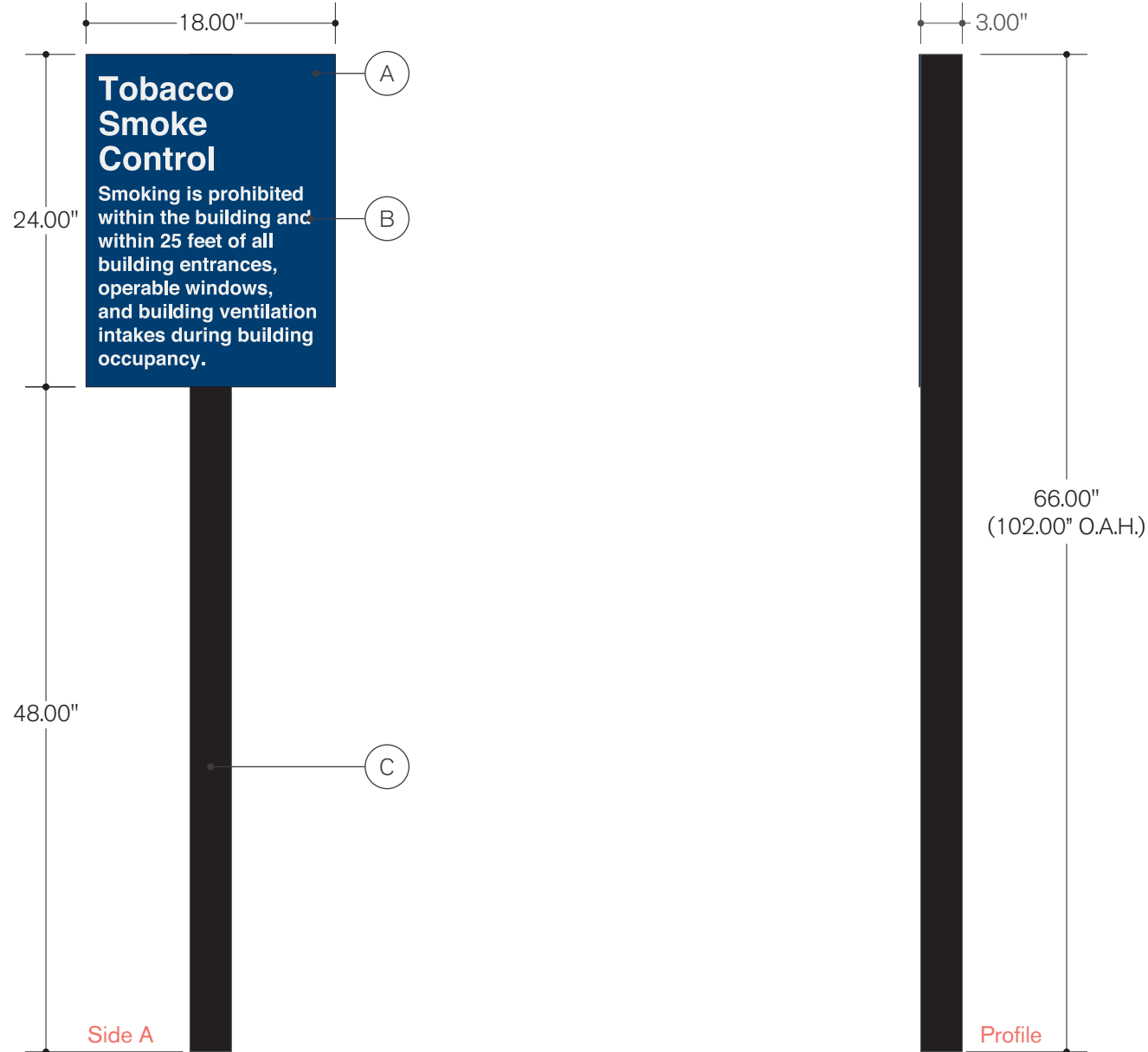
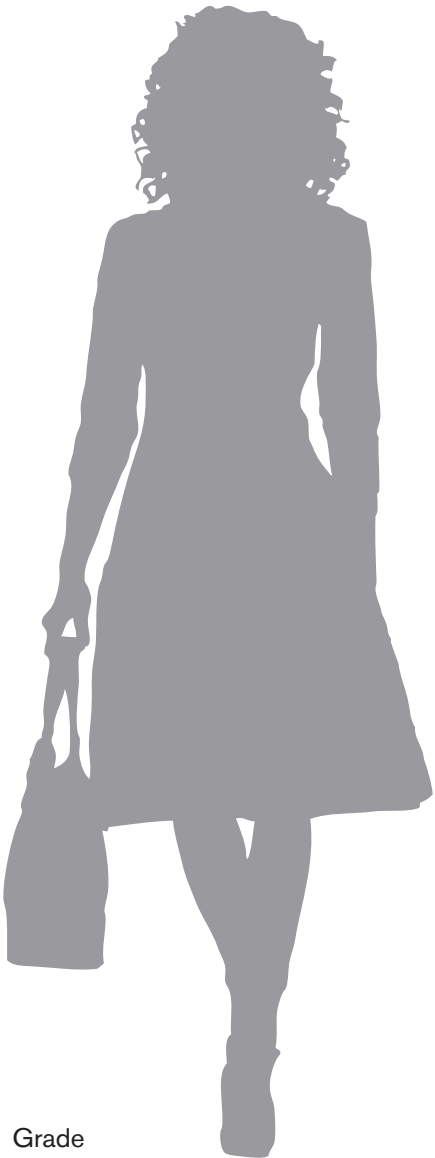

Grade

Side A

Profile

Panel

 **A** Painted .125 Aluminum
CO104 White / to match **PMS 541 C** VA Blue

Copy

 **B** First Surface Applied Vinyl
 Font: Customer Supplied Artwork
280-10 White Reflective

Post

 **C** Painted 3" Aluminum Square Tube
CO101 Black

takeform

11601 Maple Ridge Rd, Medina, NY, 14103
 P 800.528.1398 F 585.798.8889
 www.takeform.net

Signify
 EXTERIOR SIGNAGE

Project:
 Marion IN VAMC
 Campus Updates - Exterior

Date: 02.08.16 Drawn By: JB

Filename:
 DEP0005_143436_EXT_Rev6

Revisions:

04.01.16	JB
06.21.16	JB
07.21.16	JB
08.10.16	JB
08.25.16	JB
09.01.16	JB

Signify 01

Scale:
 1" = 1'-0"

Notes:

Product Approval

NO CHANGES
Approved By: _____
Date: _____
WITH CHANGES AS NOTED
Approved By: _____
Date: _____

Product will be manufactured as indicated on this document. Please review carefully.

Type EI-06.01
 S01WC-CUSTOM
 Internally Illuminated Wall Cabinet
 LED Illumination
 Mechanically Fasten to Building Fascia
 Mounting Hardware to Suit Wall Construction
QTY: 1

takeform

11601 Maple Ridge Rd, Medina, NY, 14103
 P 800.528.1398 F 585.798.8889
 www.takeform.net

Signify
 EXTERIOR SIGNAGE

Project:
 Marion IN VAMC
 Campus Updates - Exterior

Date: 02.08.16
 Drawn By: JB

Filename:
 DEP0005_150756_EXT_Rev1

Revisions:
 10.19.16 JB

Signify 01

Scale:
 1/4" = 1'-0"

Notes:
 DEP0005_143436_EXT_Rev1

Verify Mounting Surface Area prior to fabrication.

Product Approval

NO CHANGES
Approved By:
Date:
WITH CHANGES AS NOTED
Approved By:
Date:

Product will be manufactured as indicated on this document. Please review carefully.



Face Panel

(A) Painted, Routed .125 Aluminum to match **PMS 541 C** VA Blue

Illuminated Copy

(B) Push-thru 3/4" Translucent Acrylic 1/2" Proud of Face
 Font: Customer Supplied Artwork / Helvetica Bold
7328 White

Type EI-08.01
 S01WC-96-24
 Internally Illuminated Wall Cabinet
 LED Illumination
 Mechanically Fasten to Building Fascia
 Mounting Hardware to Suit Wall Construction
QTY: 1

All Message Layouts as specified
 in VA Signage Design Guide 2012

takeform

11601 Maple Ridge Rd, Medina, NY, 14103
 P 800.528.1398 F 585.798.8889
 www.takeform.net

Signify
 EXTERIOR SIGNAGE

Project:
 Marion IN VAMC
 Campus Updates - Exterior

Date: 02.08.16
 Drawn By: JB

Filename:
 DEP0005_143436_EXT_Rev6

Revisions:

04.01.16	JB
06.21.16	JB
07.21.16	JB
08.10.16	JB
08.25.16	JB
09.01.16	JB



Signify 01

Scale:
 3/4" = 1'-0"

Notes:

Verify Mounting Surface Area
 prior to fabrication.

Face Panel

 (A) Painted, Routed .125 Aluminum
 Font: Helvetica Bold
 to match **PMS 200 C**

Illuminated Copy

 (B) 3/16" Translucent Acrylic Backer
7328 White

Product Approval

NO CHANGES	
Approved By:	Date:
WITH CHANGES AS NOTED	
Approved By:	Date:

Product will be manufactured as indicated
 on this document. Please review carefully.

Type EN-06.01
 S01WP-96-24
 Non-illuminated Pan Sign
 Rail Mount to Building Fascia
 Mounting Hardware to Suit Wall Construction
QTY: 2

All Message Layouts as specified
 in VA Signage Design Guide 2012

takeform

11601 Maple Ridge Rd, Medina, NY, 14103
 P 800.528.1398 F 585.798.8889
 www.takeform.net

Signify
 EXTERIOR SIGNAGE

Project:
 Marion IN VAMC
 Campus Updates - Exterior

Date: 02.08.16
 Drawn By: JB

Filename:
 DEP0005_143436_EXT_Rev6

Revisions:
 04.01.16 JB
 06.21.16 JB
 07.21.16 JB
 08.10.16 JB
 08.25.16 JB
 09.01.16 JB

Signify 01

Scale:
 3/4" = 1'-0"

Notes:

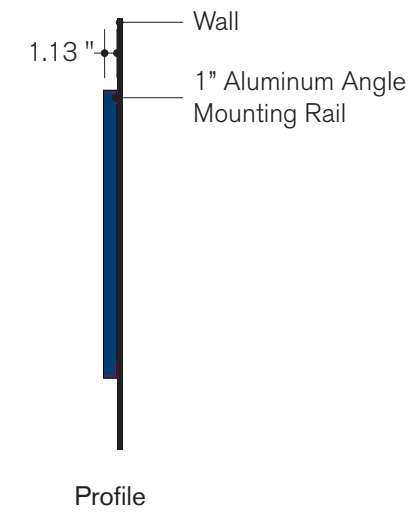
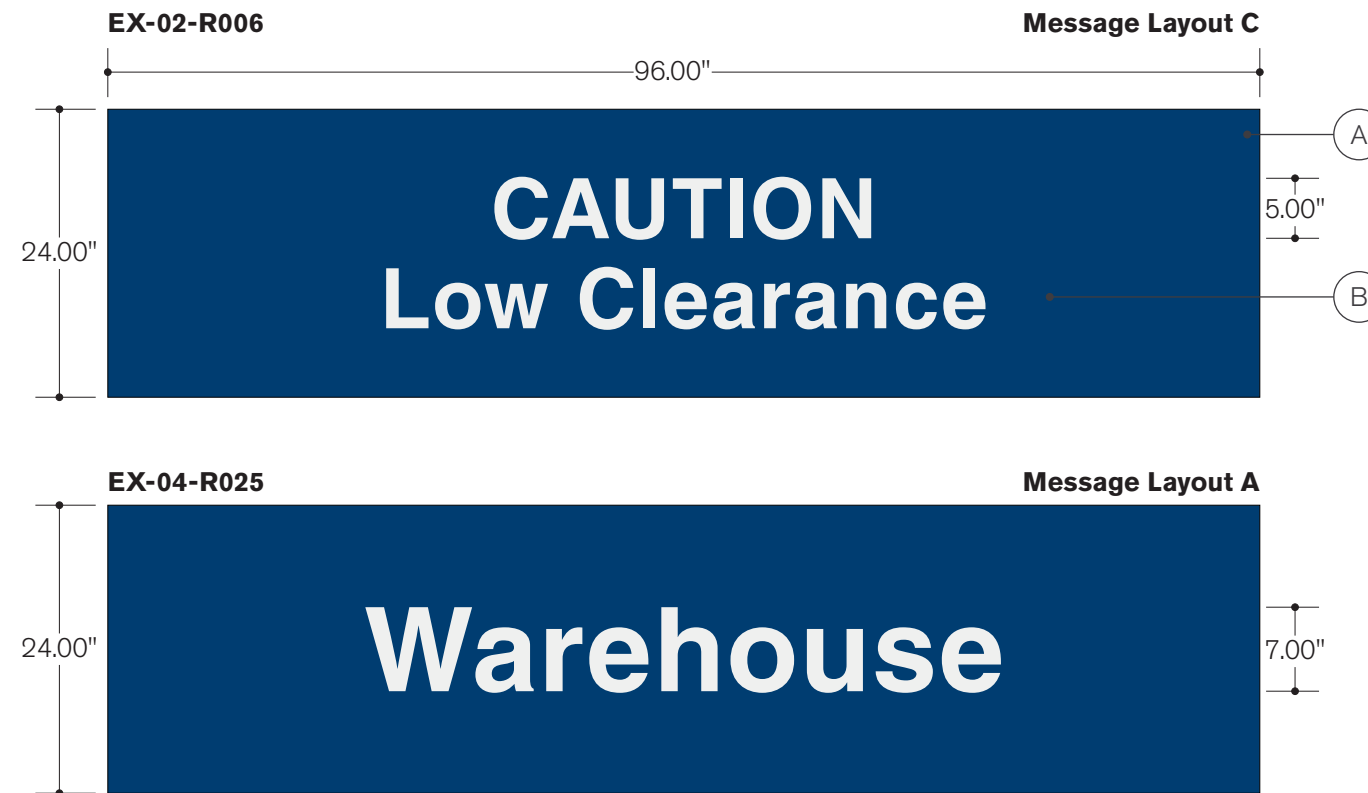

Pan

 (A) Painted 1.13" Deep Brake Formed Aluminum to match **PMS 541 C** VA Blue

Copy

 (B) First Surface Applied Vinyl
 Font: Helvetica Bold
280-10 White Reflective

Product Approval

NO CHANGES
Approved By:
Date:
WITH CHANGES AS NOTED
Approved By:
Date:

Product will be manufactured as indicated on this document. Please review carefully.

Type EN-06.06
 S01WP-24-24
 Non-illuminated Pan Sign
 Rail Mount to Building Fascia
 Mounting Hardware to Suit Wall Construction
QTY: 54

All Message Layouts as specified
 in VA Signage Design Guide 2012

takeform

11601 Maple Ridge Rd, Medina, NY, 14103
 P 800.528.1398 F 585.798.8889
 www.takeform.net

Signify
 EXTERIOR SIGNAGE

Project:
 Marion IN VAMC
 Campus Updates - Exterior

Date: 02.08.16
 Drawn By: JB

Filename:
 DEP0005_143436_EXT_Rev6

Revisions:
 04.01.16 JB
 06.21.16 JB
 07.21.16 JB
 08.10.16 JB
 08.25.16 JB
 09.01.16 JB

Signify 01

Scale:
 3/4" = 1'-0"

Notes:

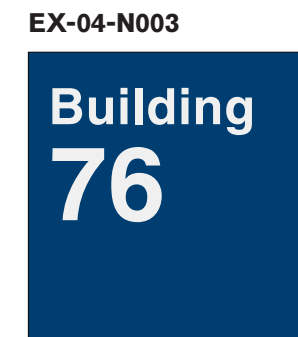
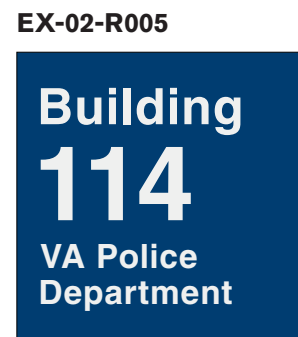
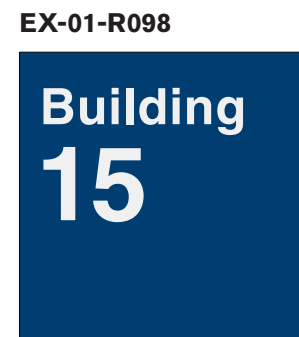
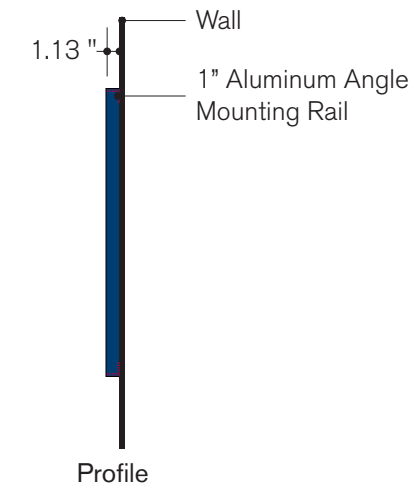
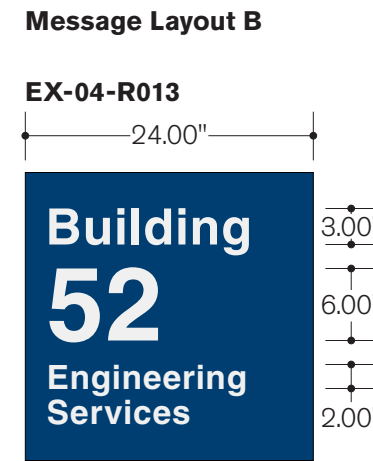
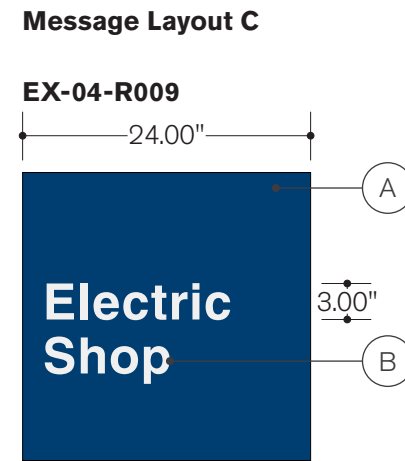
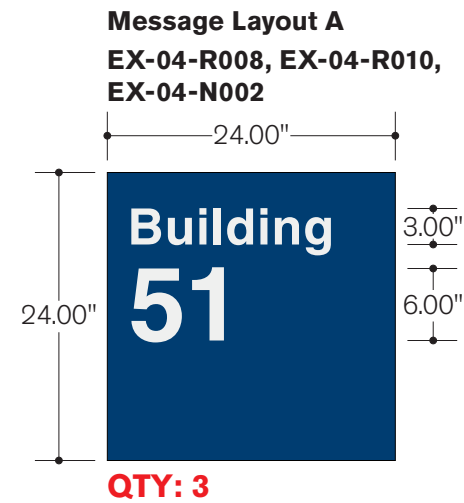

Pan

 Painted 1.13" Deep Brake Formed Aluminum to match **PMS 541 C** VA Blue

Copy

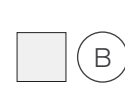
 First Surface Applied Vinyl
 Font: Helvetica Bold
280-10 White Reflective

Product Approval

NO CHANGES
Approved By:
Date:
WITH CHANGES AS NOTED
Approved By:
Date:

Product will be manufactured as indicated on this document. Please review carefully.

Project:
 Marion IN VAMC
 Campus Updates - Exterior

Date: 02.08.16
 Drawn By: JB

Filename:
 DEP0005_143436_EXT_Rev6

Revisions:

04.01.16	JB
06.21.16	JB
07.21.16	JB
08.10.16	JB
08.25.16	JB
09.01.16	JB

Signify 01

Scale:
 3/4" = 1'-0"

Notes:
 Refer to page 16 of 22 for
 fabrication details

Product Approval

NO CHANGES
Approved By: _____
Date: _____
WITH CHANGES AS NOTED
Approved By: _____
Date: _____

Product will be manufactured as indicated on this document. Please review carefully.

EX-04-N007, EX-04-R012

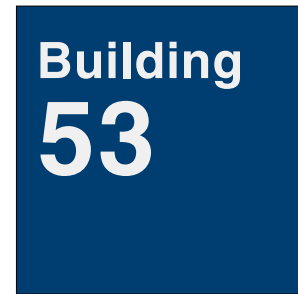

QTY: 2

EX-04-R005



EX-04-R006



EX-04-R011



EX-04-R023, EX-04-R024



QTY: 2

EX-04-R026

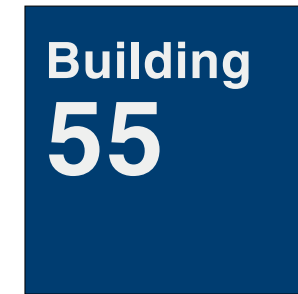

EX-04-R029, EX-04-R030



QTY: 2

EX-04-R031, EX-04-R032

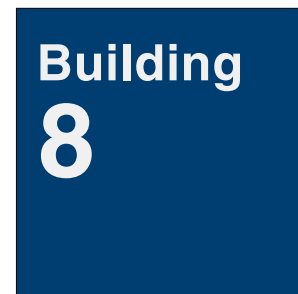

QTY: 2

EX-05-N001, EX-05-R005



QTY: 2

EX-05-N003, TBD



QTY: 2

EX-05-N004, EX-05-R026

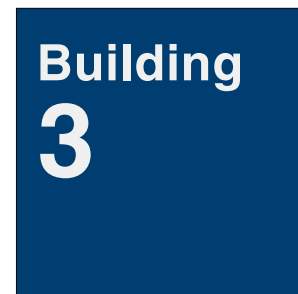

QTY: 2

EX-05-N005, EX-05-R041



QTY: 2

EX-05-N006, EX-05-R054



QTY: 2

EX-05-N007, EX-05-R068



QTY: 2

EX-05-N008, EX-05-R085

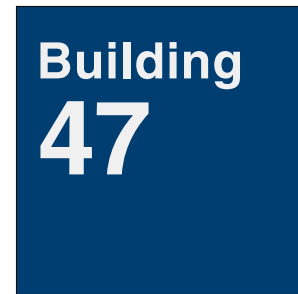

QTY: 2

EX-05-N001,



EX-04-N008



EX-05-N012, EX-05-N013



QTY: 2

EX-05-N014



Type EN-06.08.a
 S01WP-CUSTOM
 Wall Panel
 Mechanically Fasten to Mounting surface
 Mounting Hardware to suit Surface
QTY: 6

Type EN-06.08
 S01WP-12-18
 Wall Panel
 Stud Mount Flush to building Fascia
QTY: 7

All Message Layouts as specified
 in VA Signage Design Guide 2012

takeform

11601 Maple Ridge Rd, Medina, NY, 14103
 P 800.528.1398 F 585.798.8889
 www.takeform.net

Signify
 EXTERIOR SIGNAGE

Project:
 Marion IN VAMC
 Campus Updates - Exterior

Date: 02.08.16
 Drawn By: JB

Filename:
 DEP0005_143436_EXT_Rev6

Revisions:
 04.01.16 JB
 06.21.16 JB
 07.21.16 JB
 08.10.16 JB
 08.25.16 JB
 09.01.16 JB

Signify 01

Scale:
 As Noted

Notes:

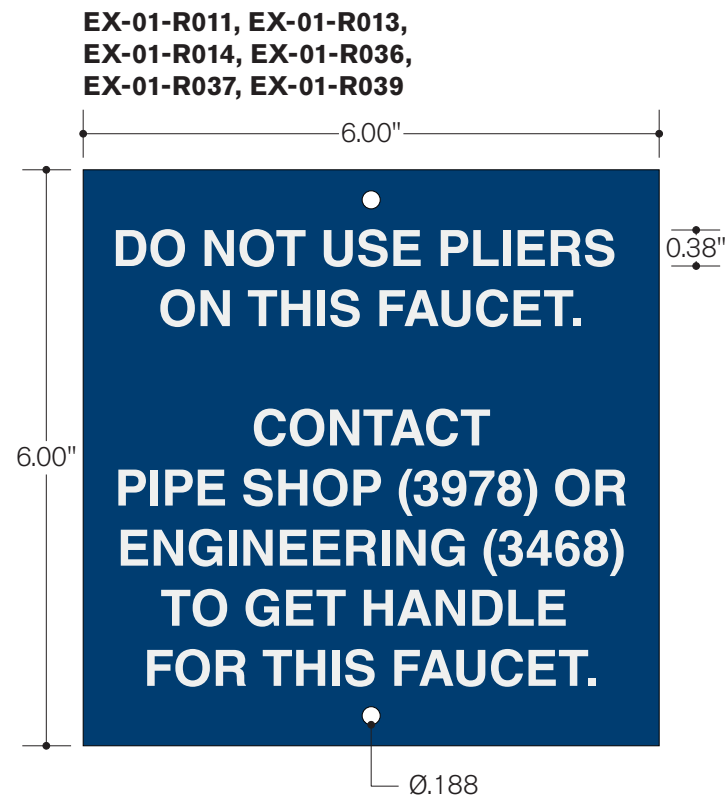

Scale
 1 : 2

Scale
 1 1/2" = 1'-0"

Panel

 Painted .125" Aluminum to match **PMS 541 C** VA Blue

Copy

 First Surface Applied Vinyl
 Font: Helvetica Bold
280-10 White Reflective

Message Layout C

EX-01-R066

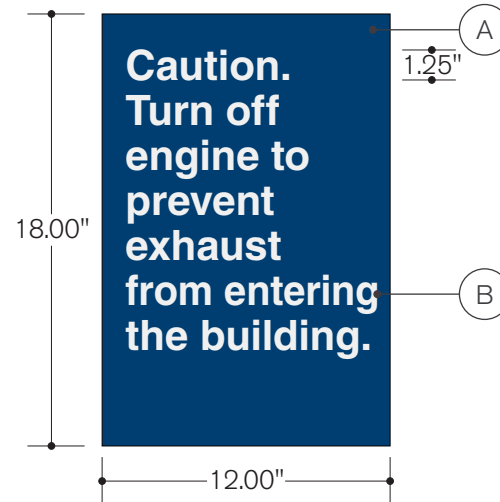

EX-01-R075

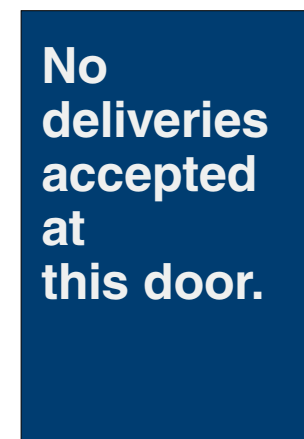

Message Layout A

EX-01-R063, EX-01-R071



EX-01-R089



Does not follow any Design Guide layout for this sign type.

EX-01-R068



EX-02-R007

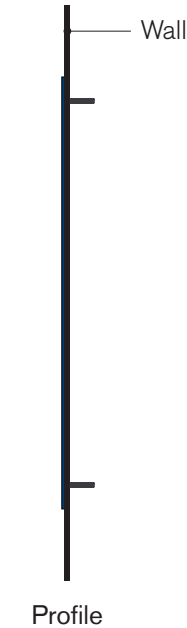
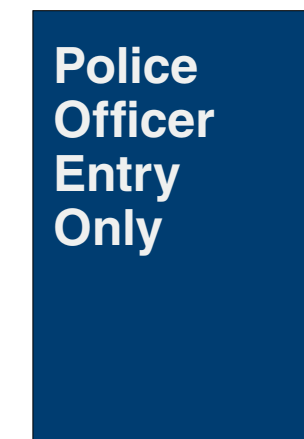

Product Approval

NO CHANGES
Approved By: _____
Date: _____
WITH CHANGES AS NOTED
Approved By: _____
Date: _____

Product will be manufactured as indicated on this document. Please review carefully.

Type PL-12.06
 S01FP-24-24
 Double Sided Flag Panel
 Mechanically Fasten to Existing Lamp Posts
 Mounting Hardware - **AB-10** Adjustable Band Bracket Assembly w/
BWB24 Wing Bracket

QTY: 11

All Message Layouts as specified
 in VA Signage Design Guide 2012

takeform

11601 Maple Ridge Rd, Medina, NY, 14103
 P 800.528.1398 F 585.798.8889
 www.takeform.net

Signify
 EXTERIOR SIGNAGE

Project:
 Marion IN VAMC
 Campus Updates - Exterior

Date: 02.08.16
 Drawn By: JB

Filename:
 DEP0005_143436_EXT_Rev6

Revisions:

04.01.16	JB
06.21.16	JB
07.21.16	JB
08.10.16	JB
08.25.16	JB
09.01.16	JB

Signify 01

Scale:
 1" = 1'-0"

Notes:

Message Layout A

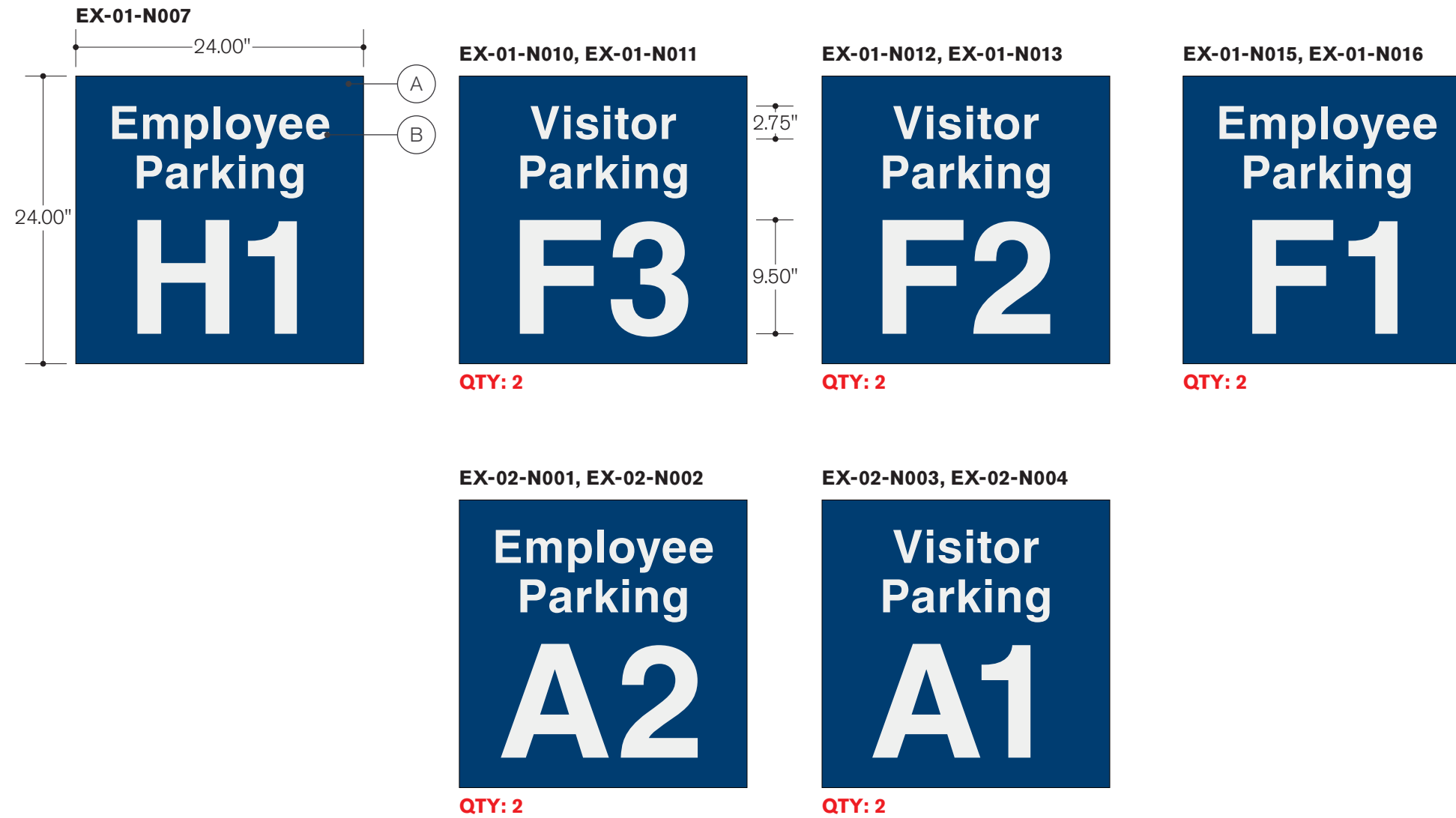

Panel

 Painted .125" Aluminum to match **PMS 541 C** VA Blue

Copy

 First Surface Applied Vinyl
 Font: Helvetica Bold
280-10 White Reflective

Mounting Detail

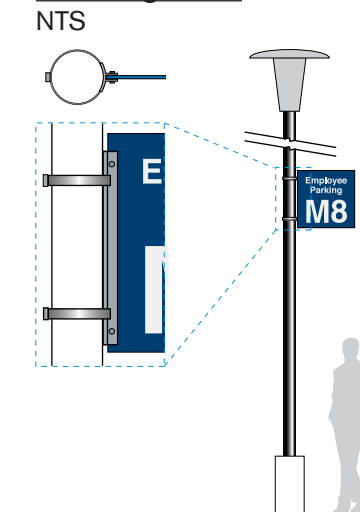

Product Approval

NO CHANGES	
Approved By:	Date:
WITH CHANGES AS NOTED	
Approved By:	Date:

Product will be manufactured as indicated on this document. Please review carefully.

Type IN-02.01
MXA20X6-A
 Graphic Panel
 Stud Mount Flush to Building Fascia w/
 Loctite PL Premium Construction Adhesive
QTY: 32

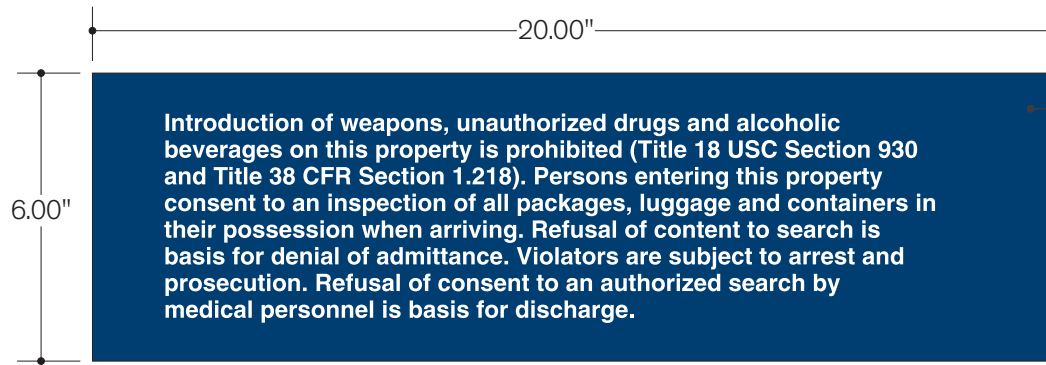

EX-01-N023, EX-01-N032, EX-01-N037, EX-01-N049, EX-01-N053, EX-01-N061, EX-01-N066, EX-01-N074, EX-01-N078, EX-01-N082, EX-01-N086, EX-01-N092, EX-01-N098, EX-01-N102, EX-01-R025, EX-02-R008, EX-04-N009, EX-04-N013, EX-04-R014, EX-05-N018, EX-05-N022, EX-05-N029, EX-05-N033, EX-05-N040, EX-05-N045, EX-05-N050, EX-05-N054, EX-05-N061, EX-05-N065, EX-05-N071, EX-05-N076, EX-05-N080

All Message Layouts as specified
 in VA Signage Design Guide 2012

Type IN-02.02
MXA20X6-A
 Graphic Panel
 Stud Mount Flush to Building Fascia w/
 Loctite PL Premium Construction Adhesive
QTY: 31

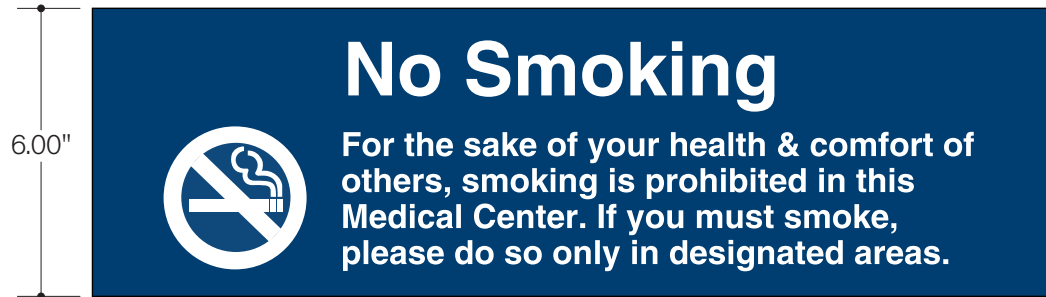

EX-01-N024, EX-01-N033, EX-01-N038, EX-01-N050, EX-01-N054, EX-01-N062, EX-01-N067, EX-01-N075, EX-01-N079, EX-01-N083, EX-01-N087, EX-01-N093, EX-01-N099, EX-01-N103, EX-01-R017, EX-01-R038, EX-04-N010, EX-04-N014, EX-05-N019, EX-05-N023, EX-05-N030, EX-05-N034, EX-05-N041, EX-05-N046, EX-05-N051, EX-05-N055, EX-05-N062, EX-05-N066, EX-05-N072, EX-05-N077, EX-05-N081

Type IN-02.03
MXA20X6-A
 Graphic Panel
 Stud Mount Flush to Building Fascia w/
 Loctite PL Premium Construction Adhesive
QTY: 29

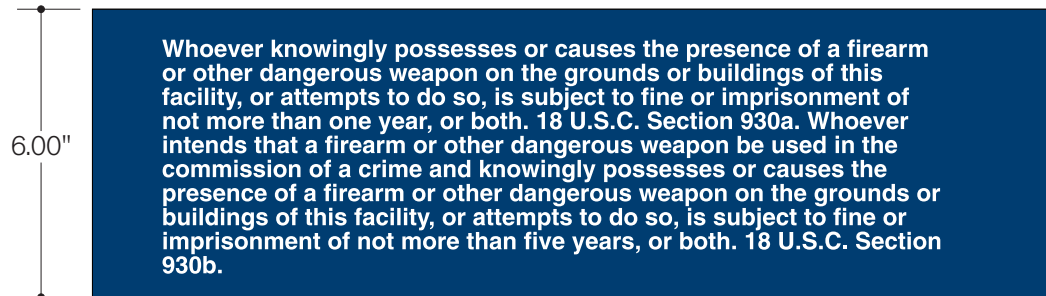

EX-01-N025, EX-01-N034, EX-01-N039, EX-01-N051, EX-01-N055, EX-01-N063, EX-01-N068, EX-01-N076, EX-01-N080, EX-01-N084, EX-01-N088, EX-01-N094, EX-01-N100, EX-01-N104, EX-04-N011, EX-04-N015, EX-05-N020, EX-05-N024, EX-05-N031, EX-05-N035, EX-05-N042, EX-05-N047, EX-05-N052, EX-05-N056, EX-05-N063, EX-05-N067, EX-05-N073, EX-05-N078, EX-05-N082

Type IN-02.10
MXA20X6-A
 Graphic Panel
 Stud Mount Flush to Building Fascia w/
 Loctite PL Premium Construction Adhesive
QTY: 75



EX-01-N026, EX-01-N027, EX-01-N028, EX-01-N029, EX-01-N030, EX-01-N031, EX-01-N035, EX-01-N036, EX-01-N040, EX-01-N041, EX-01-N042, EX-01-N043, EX-01-N044, EX-01-N045, EX-01-N046, EX-01-N047, EX-01-N048, EX-01-N052, EX-01-N056, EX-01-N057, EX-01-N058, EX-01-N059, EX-01-N060, EX-01-N064, EX-01-N065, EX-01-N069, EX-01-N070, EX-01-N071, EX-01-N072, EX-01-N073, EX-01-N077, EX-01-N081, EX-01-N085, EX-01-N089, EX-01-N090, EX-01-N091, EX-01-N095, EX-01-N096, EX-01-N097, EX-01-N101, EX-01-N105, EX-01-N106, EX-04-N012, EX-04-N016, EX-05-N016, EX-05-N017, EX-05-N021, EX-05-N025, EX-05-N026, EX-05-N027, EX-05-N028, EX-05-N032, EX-05-N036, EX-05-N037, EX-05-N038, EX-05-N039, EX-05-N043, EX-05-N044, EX-05-N048, EX-05-N049, EX-05-N053, EX-05-N057, EX-05-N058, EX-05-N059, EX-05-N060, EX-05-N064, EX-05-N068, EX-05-N069, EX-05-N070, EX-05-N074, EX-05-N075, EX-05-N079, EX-05-N083, EX-05-N084, EX-05-N085

takeform

11601 Maple Ridge Rd, Medina, NY, 14103
 P 800.528.1398 F 585.798.8889
 www.takeform.net

Moxie

Project:
 Marion IN VAMC
 Campus Updates - Exterior

Date: 02.08.16
 Drawn By: JB

Filename:
 DEP0005_143436_EXT_Rev6

Revisions:

04.01.16	JB
06.21.16	JB
07.21.16	JB
08.10.16	JB
08.25.16	JB
09.01.16	JB

Scale:
 3" = 1'-0"

Design Review By:

Notes:

Product Approval

NO CHANGES	
Approved By:	Date:
WITH CHANGES AS NOTED	
Approved By:	Date:

Product will be manufactured as indicated on this document. Please review carefully.

Panel
 6mm ACM
White

Graphic
 Direct Print
 Font: Helvetica Bold / Helvetica
TKF 662 to match **PMS 541 C** VA Blue / **TKF 308** Blue / **TKF 200** Red / **TKF White** / **TKF Black**

Type IN-02.04
MXA9X9-A
Graphic Panel
Stud Mount Flush to Building Fascia w/
Loctite PL Premium Construction Adhesive
QTY: 3

Type IN-01.16
MXA9X9-A
Graphic Panel
Stud Mount Flush to Building Fascia w/
Loctite PL Premium Construction Adhesive
QTY: 3

Type IN-01.21
MXA9X9-A
Graphic Panel
Stud Mount Flush to Building Fascia w/
Loctite PL Premium Construction Adhesive
QTY: 1

EX-01-N107, EX-01-N108, EX-01-R020

EX-01-R008, EX-01-R018, EX-01-R058

EX-01-R034

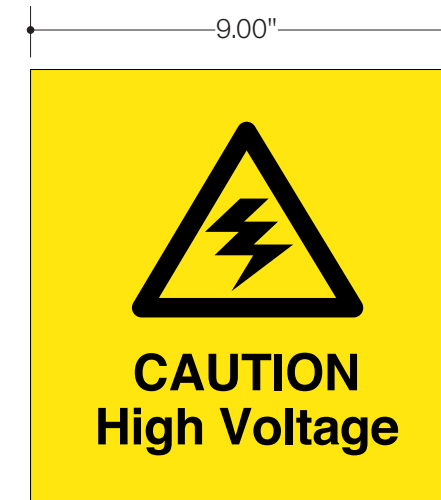
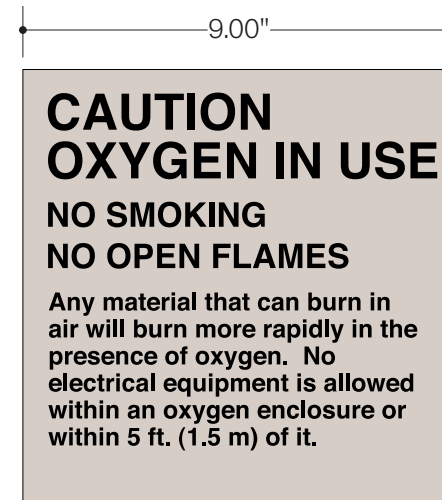

Project:
Marion IN VAMC
Campus Updates - Exterior

Date: 02.08.16
Drawn By: JB

Filename:
DEP0005_143436_EXT_Rev6

Revisions:

04.01.16	JB
06.21.16	JB
07.21.16	JB
08.10.16	JB
08.25.16	JB
09.01.16	JB

Scale:
3" = 1'-0"

Design Review By:

Notes:

Panel
6mm ACM
White

Graphic

Direct Print
Font: Helvetica Bold
TKF 662 to match PMS 541 C VA Blue / from Rendering / TKF White / TKF Black

Product Approval

NO CHANGES
Approved By: _____
Date: _____
WITH CHANGES AS NOTED
Approved By: _____
Date: _____

Product will be manufactured as indicated on this document. Please review carefully.

Type EN-09.04
 Dimensional Copy
 Stud Mount Flush to Building Fascia
QTY: 1 set

takeform

11601 Maple Ridge Rd, Medina, NY, 14103
 P 800.528.1398 F 585.798.8889
 www.takeform.net

Ethos
 LETTERS & LOGOS

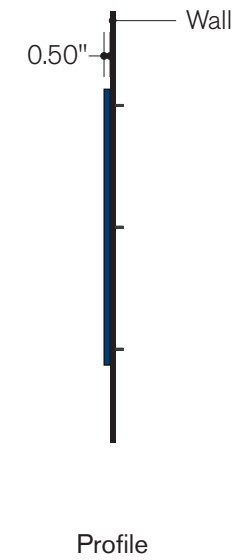

Project:
 Marion IN VAMC
 Campus Updates - Exterior

Date: 02.08.16
 Drawn By: JB

Filename:
 DEP0005_143436_EXT_Rev6

Revisions:

04.01.16	JB
06.21.16	JB
07.21.16	JB
08.10.16	JB
08.25.16	JB
09.01.16	JB

Scale:
 3/4" = 1'-0"

Design Review By:

Notes:

Site Survey Required

Verify mounting surface area prior to fabrication.

Dimensional Copy

  Painted, 1/2" Deep Fabricated Stainless Steel
 Font: Customer Supplied Artwork / Helvetica Bold
 to match **PMS 541 C** VA Blue

Product Approval

NO CHANGES
Approved By:
Date:
WITH CHANGES AS NOTED
Approved By:
Date:

Product will be manufactured as indicated on this document. Please review carefully.

Rendering

Client:
Valiant Construction LLC

Project:
Marion IN VAMC
substitution samples

Date: 01.06.16 Drawn By: TW

Filename:
DEP0005_143436_RND_rev12

Design Review By:
FB

Revisions:
 02.24.16TW update layout
 04.21.16TW update category
 05.10.16 TW update MH signs
 06.13.16TW add signs
 07.18.16TW add signs
 07.28.16TW update headers
 08.05.16TW add signs
 08.11.16TW add signs
 08.25.16JLG add signs
 09.01.16TW add 14.11p
 09.02.16TW add IN15.52a

Life Safety

- Notes:
- Uppercase, brailled copy to be raised. All other copy, including pictograms, to be printed unless otherwise noted.
 - Sign copy shown is for sample purposes only.
 - Window backer if required: CO104 White Applique

Product Approval

As Is As Noted
 Approved By: _____
 Date: _____

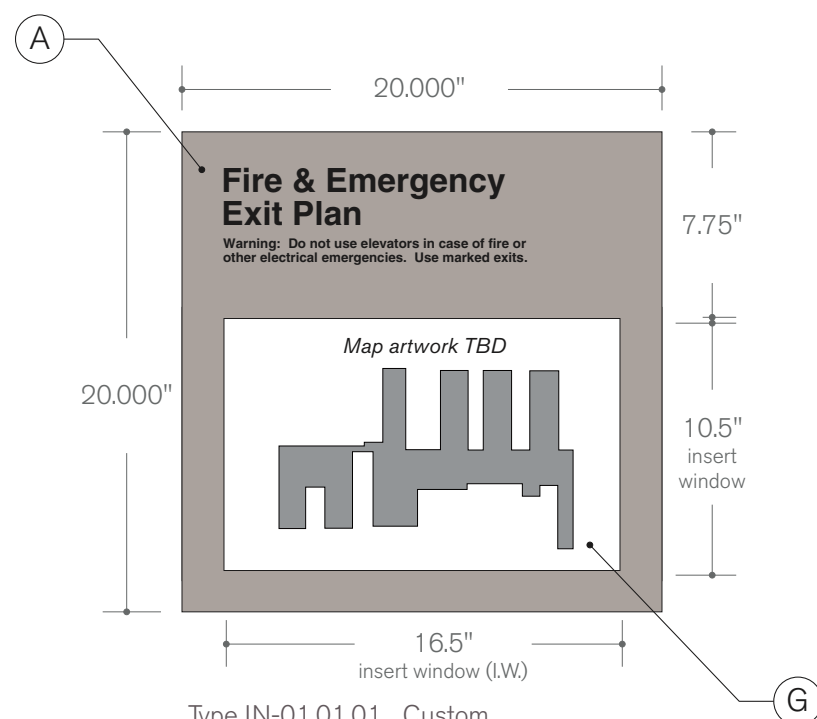

Type IN-01.01.01 Custom
20"w X 20"h
Accepts Pass-Thru Insert
FUVID, square corners

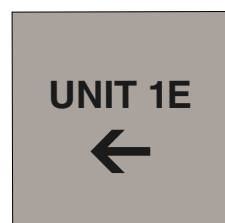

Type IN-01.03 CS9x9-T
9"w X 9"h
ACM



Type IN-01.04 CS9x6-T
9"w X 6"h
ACM



Type IN-01.05 CS9x9-T
9"w X 9"h
ACM



Type IN-01.05 alt layout

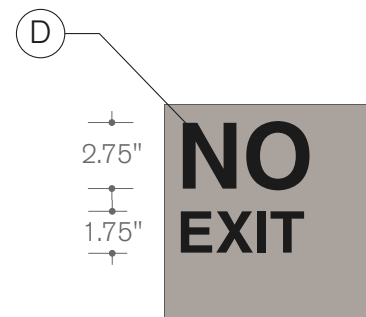

Type IN-01.06 CS9x9-T
9"w X 9"h
ACM



Type IN-01.07.01 CS22x9-T
22"w X 9"h
ACM

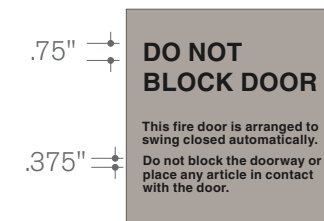

Type IN-01.08 CS9x9-T
9"w X 9"h
ACM

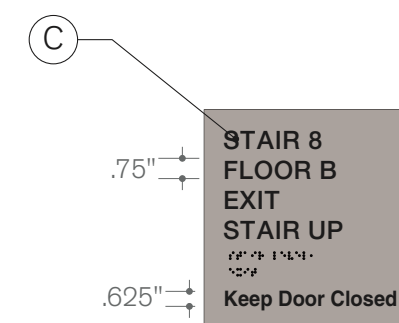

Type IN-01.10 CS9x9-T
9"w X 9"h
ACM
Raised copy & Braille

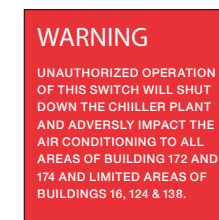

Type IN-01.12 CS9x9-T
9"w X 9"h
ACM

No Frames

Direct Print Background
 (A) TKF Concrete

Raised Copy
 (C) CO101 Black
 Font Helvetica ADA

Direct Print Copy
 (E) TKF White
 Font Helvetica ADA/Helvetica Bold

Insert
 (G) Media: White Paper;
 Font: Helvetica ADA, Helvetica Bold;
 Graphics/Copy Color: Black

Direct Print Background
 (B) TKF 185
 (to match OSHA red)

Direct Print Copy
 (D) TKF Black
 Font Helvetica ADA/Helvetica Bold
 Helvetica Bold Condensed

Direct Print Graphic
 (F) TKF White

Rendering

Client:
Valiant Construction LLC

Project:
Marion IN VAMC
substitution samples

Date: 01.06.16
 Drawn By: TW

Filename:
DEP0005_143436_RND_rev12

Design Review By:
FB

- Revisions:
- 02.24.16TW update layout
 - 04.21.16TW update category
 - 05.10.16 TW update MH signs
 - 06.13.16TW add signs
 - 07.18.16TW add signs
 - 07.28.16TW update headers
 - 08.05.16TW add signs
 - 08.11.16TW add signs
 - 08.25.16JLG add signs
 - 09.01.16TW add 14.11p
 - 09.02.16TW add IN15.52a

Life Safety

- Notes:
- Uppercase, brailled copy to be raised. All other copy, including pictograms, to be printed unless otherwise noted.
 - Sign copy shown is for sample purposes only.
 - Window backer if required: CO104 White Applique

Product Approval

As Is As Noted
 Approved By: _____
 Date: _____

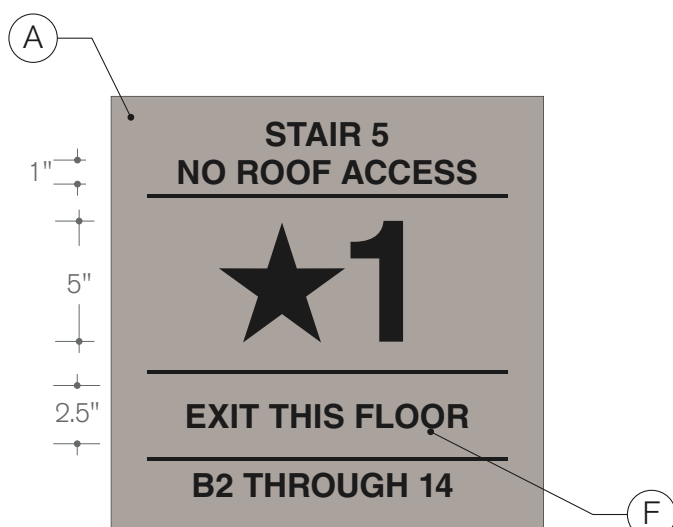

Type IN-01.11 CS18x18-T
18"w X 18"h
ACM



Type IN-01.11 alt. layout

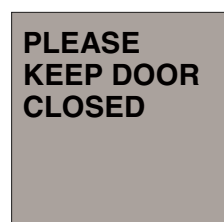

Type IN-01.16 CS9x9-T
9"w X 9"h
ACM

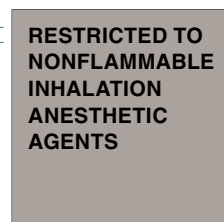

Type IN-01.18 CS9x9-T
9"w X 9"h
ACM

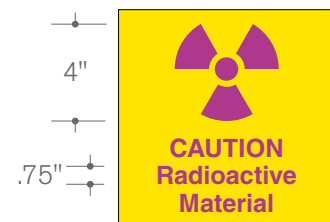

Type IN-01.19 CS9x9-T
9"w X 9"h
ACM



Type IN-01.20 CS9x9-T
9"w X 9"h
ACM

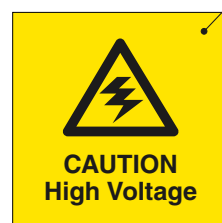

Type IN-01.21 CS9x9-T
9"w X 9"h
ACM

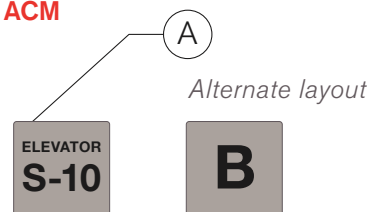

Type IN-01.18E Custom
4"w X 4"h
Fuvid Construction
No Frame



Type IN-01.22 CS9x9-T
9"w X 9"h
ACM



Type IN-01.23 CS9x9-T
9"w X 9"h
ACM

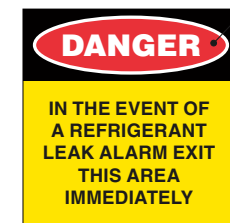

Type IN-01.23a CS9x9-T
9"w X 9"h
ACM

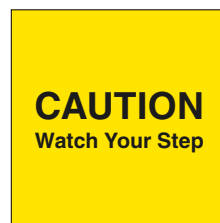

Type IN-01.24 CS9x9-T
9"w X 9"h
ACM

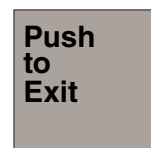

Type IN-01.26 CS6x6-T
6"w X 6"h
ACM



Type IN-01.27 CS9x3-T
9"w X 3"h
ACM



Type IN-01.34.02.01 CS9x3-T
9"w X 3"h
ACM

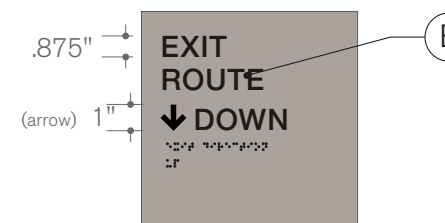

Type IN-01.29 CS9x9-T
9"w X 9"h
ACM
Raised copy & Braille

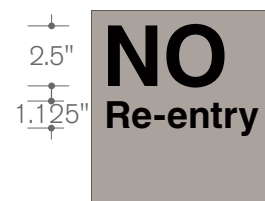

Type IN-01.30 CS9x9-T
9"w X 9"h
ACM

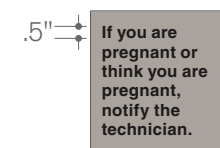

Type IN-01.32 CS6x6-T
6"w X 6"h
ACM

No Frames

Direct Print Background



TKF Concrete

Direct Print Background

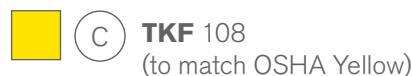

TKF 108
(to match OSHA Yellow)

Direct Print Background



TKF 185
(to match OSHA red)

Direct Print Copy/Graphic

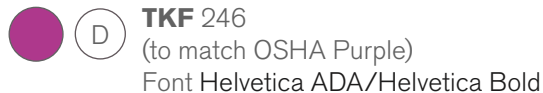

TKF 246
(to match OSHA Purple)
Font Helvetica ADA/Helvetica Bold

Raised Copy



CO101 Black
Font Helvetica ADA

Direct Print Copy/Graphic



TKF White
Font Helvetica ADA/Helvetica Bold

Direct Print Copy/Graphic

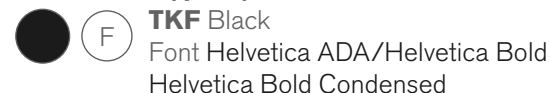

TKF Black
Font Helvetica ADA/Helvetica Bold
Helvetica Bold Condensed

Looking for
IN-01.22.01 or IN-01.26.06

Rendering

Client:
Valiant Construction LLC

Project:
Marion IN VAMC
substitution samples

Date: 01.06.16 Drawn By: TW

Filename:
DEP0005_143436_RND_rev12

Design Review By:
FB

Revisions:
 02.24.16TW update layout
 04.21.16TW update category
 05.10.16 TW update MH signs
 06.13.16TW add signs
 07.18.16TW add signs
 07.28.16TW update headers
 08.05.16TW add signs
 08.11.16TW add signs
 08.25.16JLG add signs
 09.01.16TW add 14.11p
 09.02.16TW add IN15.52a

Room ID

- Notes:
- **Uppercase, brailled copy to be raised. All other copy, including pictograms, to be printed unless otherwise noted.**
 - Sign copy shown is for sample purposes only.
 - Window backer if required: CO104 White Applique

Product Approval

As Is As Noted
 Approved By: _____
 Date: _____

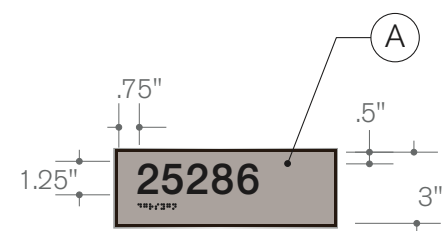

Type IN-03.01 Custom
 9"w X 3"h (Header Size)
 9.25"w X 3.25"h (Frame size)
with Frame

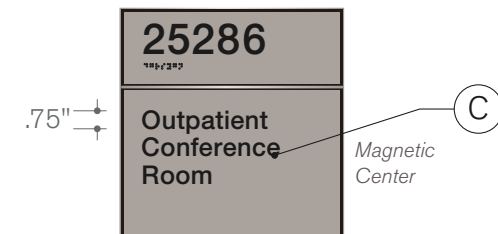

Type IN-04.01 Custom
 9"w X 3"h (Header Size)
 9"w X 6"h (Center Size)
 9.25"w X 9.5"h (Frame size)
with Frame

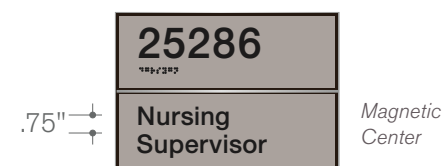

Type IN-04.02 Custom
 9"w X 3"h (Header Size)
 9"w X 3"h (Center Size)
 9.25"w X 6.5"h (Frame size)
with Frame

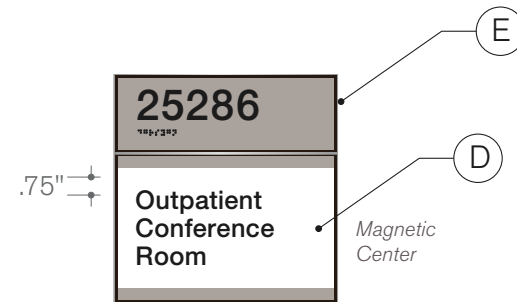

Type IN-04.03 Custom
 9"w X 3"h (Header Size)
 9"w X 6"h (Center Size, Accepts Insert, Magnetic)
 9.25"w X 9.5"h (Frame size)
with Frame

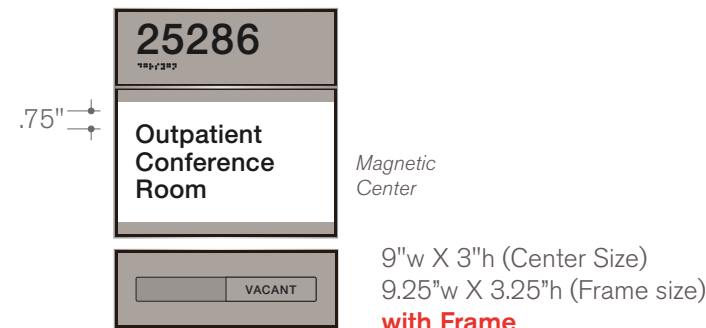

Type IN-04.03s Custom
 9"w X 3"h (Header Size)
 9"w X 6"h (Center Size, Accepts Insert, Magnetic)
 9.25"w X 9.5"h (Frame size)
with Frame

Looking for IN-08.07

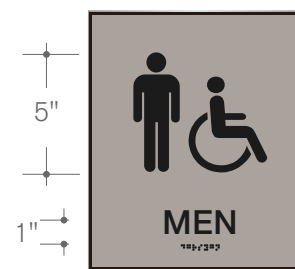

Type IN-09.01 Custom
 9"w X 10.5"h (Center Size)
 9.25"w X 10.75"h (Frame size)
with Frame



Type IN-09.01s Custom

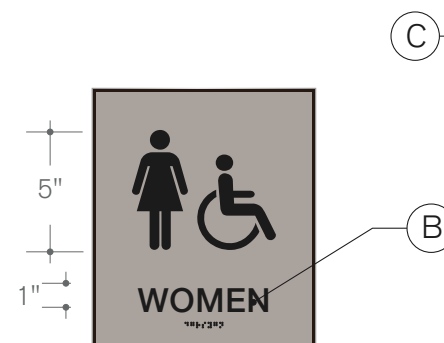

Type IN-09.02 Custom
 9"w X 10.5"h (Center Size)
 9.25"w X 10.75"h (Frame size)
with Frame

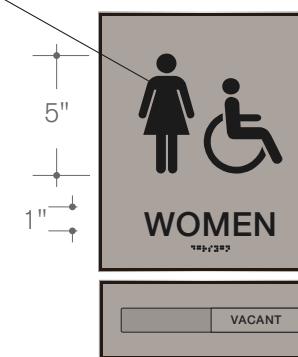

Type IN-09.02s Custom



Type IN-09.03 Custom
 9"w X 10.5"h (Center Size)
 9.25"w X 10.75"h (Frame size)
with Frame



Type IN-09.03s Custom

Direct Print Background



Direct Print Copy/Graphic

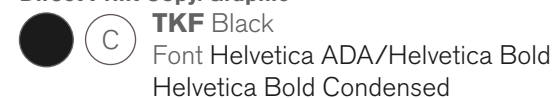

Frame



Raised Copy



Insert

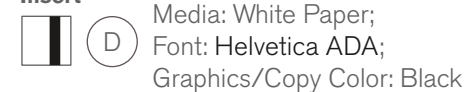

CONSTRUCTION NOTES (Refer to Engineering Drawings for additional details):

Header: .080 NG face 1/8" white acrylic w/ adhesive back, second surface printed, with surfaced applied applique and Braille
Center w/bezels: Magnetically Mounted, 080 NG face 1/8" white acrylic w/ adhesive back, second surface printed.
Frame: JRS Frame #240 outside 3/8 depth, included divider bar and inside metal, With matte black metal backer.

Rendering

Client:
Valiant Construction LLC

Project:
Marion IN VAMC
substitution samples

Date: 01.06.16 Drawn By: TW

Filename:
DEP0005_143436_RND_rev12

Design Review By:
FB

Revisions:
 02.24.16TW update layout
 04.21.16TW update category
 05.10.16 TW update MH signs
 06.13.16TW add signs
 07.18.16TW add signs
 07.28.16TW update headers
 08.05.16TW add signs
 08.11.16TW add signs
 08.25.16JLG add signs
 09.01.16TW add 14.11p
 09.02.16TW add IN15.52a

Restroom w/ slider

- Notes:
- **Uppercase, brailled copy to be raised. All other copy, including pictograms, to be printed unless otherwise noted.**
 - Sign copy shown is for sample purposes only.
 - Window backer if required: CO104 White Applique

Product Approval

As Is As Noted
 Approved By: _____
 Date: _____

Type IN-09.04 Custom
 9"w X 10.5"h (Center Size)
 9.25"w X 10.75"h (Frame size)
with Frame

Type IN-09.04s Custom
 9"w X 3"h (Center Size)
 9.25"w X 3.25"h (Frame size)
with Frame

Type IN-09.05 Custom
 9"w X 10.5"h (Center Size)
 9.25"w X 10.75"h (Frame size)
with Frame

Type IN-09.05s Custom
 9"w X 3"h (Center Size)
 9.25"w X 3.25"h (Frame size)
with Frame

Type IN-09.06 Custom
 9"w X 10.5"h (Center Size)
 9.25"w X 10.75"h (Frame size)
with Frame

Type IN-09.06s Custom
 9"w X 3"h (Center Size)
 9.25"w X 3.25"h (Frame size)
with Frame

Direct Print Background

(A) **TKF Concrete**

Raised Copy

(B) **CO101 Black**
 Font Helvetica ADA

Direct Print Copy/Graphic

(C) **TKF Black**
 Font Helvetica ADA/Helvetica Bold
 Helvetica Bold Condensed

Frame

(D) **JRS Frame #240**

CONSTRUCTION NOTES (Refer to Engineering Drawings for additional details):

Header: .080 NG face 1/8" white acrylic w/ adhesive back, second surface printed, with surfaced applied applique and Braille
Center w/bezels: Magnetically Mounted, 080 NG face 1/8" white acrylic w/ adhesive back, second surface printed.
Frame: JRS Frame #240 outside 3/8 depth, included divider bar and inside metal, With matte black metal backer.

Rendering

Client:
Valiant Construction LLC

Project:
Marion IN VAMC
substitution samples

Date: 01.06.16 Drawn By: TW

Filename:
DEP0005_143436_RND_rev12

Design Review By:
FB

Revisions:
 02.24.16TW update layout
 04.21.16TW update category
 05.10.16 TW update MH signs
 06.13.16TW add signs
 07.18.16TW add signs
 07.28.16TW update headers
 08.05.16TW add signs
 08.11.16TW add signs
 08.25.16JLG add signs
 09.01.16TW add 14.11p
 09.02.16TW add IN15.52a

Informational

- Notes:
- **Uppercase, brailled copy to be raised. All other copy, including pictograms, to be printed unless otherwise noted.**
 - Sign copy shown is for sample purposes only.
 - Window backer if required: CO104 White Applique

Product Approval

As Is As Noted
 Approved By: _____
 Date: _____

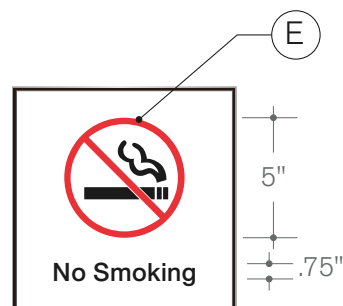

Type IN-08.01 CSA9X9-T + Frame
 9"w X 9"h (Center Size)
 9.25"w X 9.25"h (Frame size)
4 mm ACM with Frame

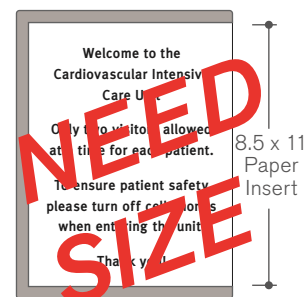

Type IN-10.01
 9.0"w X 12.0"h
 Accepts Insert
Fuvid

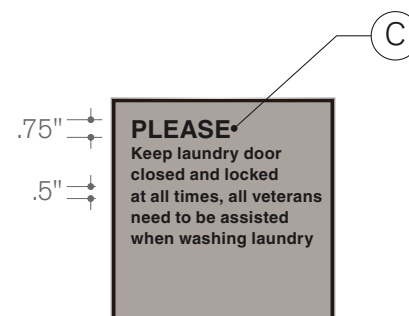

Type IN-11.01 CSA9X9-T + Frame
 9"w X 9"h (Center Size)
 9.25"w X 9.25"h (Frame size)
4 mm ACM with Frame

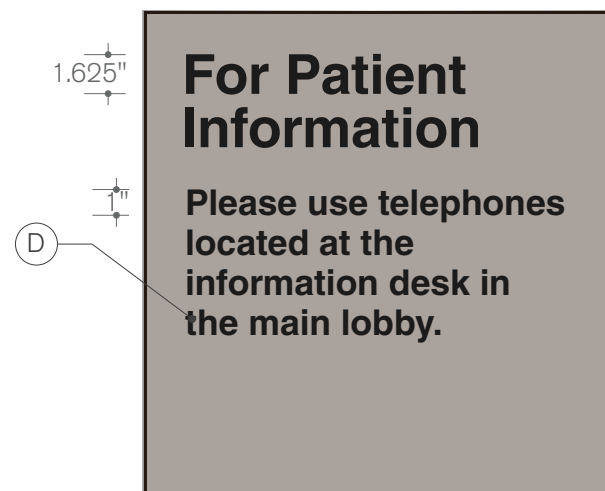

Type IN-11.03 CSA20X20-T + Frame
 20"w X 20"h (Center Size)
 20.25"w X 20.25"h (Frame size)
4 mm ACM with Frame

Magnetic Center

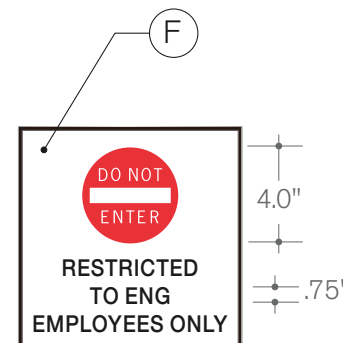

Type IN-08.02 CSA9X9-T + Frame
 9"w X 9"h (Center Size)
 9.25"w X 9.25"h (Frame size)
4 mm ACM with Frame

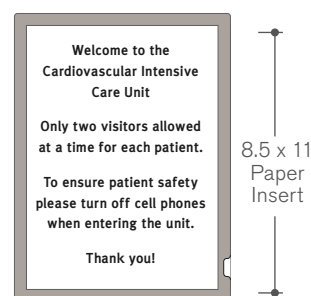

Type IN-10.05 Custom
 9.0"w X 12.0"h
 Accepts Insert
Fuvid

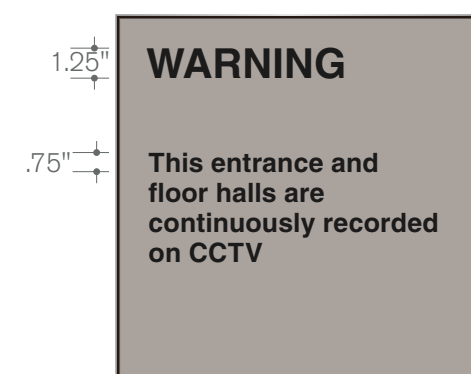

Type IN-11.02 CSA15X15-T + frame
 15"w X 15"h (Center Size)
 15.25"w X 15.25"h (Frame size)
4 mm ACM with Frame



Type IN-11.04 CSA15X15-T + frame
 6"w X 6"h (Center Size)
 6.25"w X 6.25"h (Frame size)
4 mm ACM with Frame

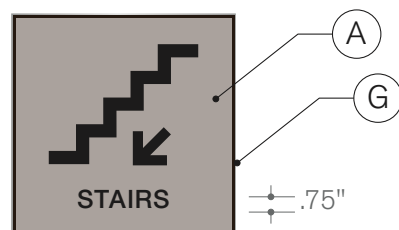

Type IN-09.08 CSA9X9-T + Frame
 9"w X 9"h (Center Size)
 9.25"w X 9.25"h (Frame size)
4 mm ACM with Frame

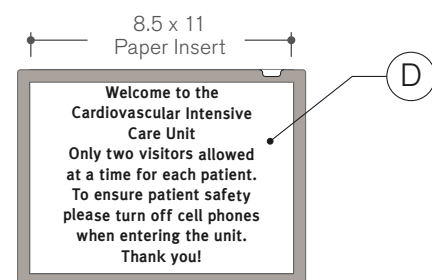

Type IN-10.06
 9.0"w X 12.0"h
 Accepts Insert
Fuvid

Direct Print Background
 (A) TKF Concrete

Direct Print Copy/Graphic
 (C) TKF Black
 Font Helvetica ADA/Helvetica Bold
 Helvetica Bold Condensed

Direct Print Copy/Graphic
 (E) TKF White, TKF 185
 Font Helvetica ADA/Helvetica Bold

Raised Copy
 (B) CO101 Black
 Font Helvetica ADA

Insert
 (D) Media: White Paper;
 Font: Helvetica ADA;
 Graphics/Copy Color: Black

Direct Print Background
 (F) TKF White

Frame
 (G) JRS Frame #240

CONSTRUCTION NOTES (Refer to Engineering Drawings for additional details):
Header: .080 NG face 1/8" white acrylic w/ adhesive back, second surface printed, with surfaced applied applique and Braille
Center w/bezels: Magnetically Mounted, 080 NG face 1/8" white acrylic w/ adhesive back, second surface printed.
Frame: JRS Frame #240 outside 3/8 depth, included divider bar and inside metal, With matte black metal backer.

Rendering

Client:
Valiant Construction LLC

Project:
Marion IN VAMC
substitution samples

Date: 01.06.16 Drawn By: TW

Filename:
DEP0005_143436_RND_rev12

Design Review By:
FB

Revisions:
 02.24.16TW update layout
 04.21.16TW update category
 05.10.16 TW update MH signs
 06.13.16TW add signs
 07.18.16TW add signs
 07.28.16TW update headers
 08.05.16TW add signs
 08.11.16TW add signs
 08.25.16JLG add signs
 09.01.16TW add 14.11p
 09.02.16TW add IN15.52a

Wayfinding

- Notes:
- **Uppercase, brailled copy to be raised. All other copy, including pictograms, to be printed unless otherwise noted.**
 - Sign copy shown is for sample purposes only.
 - Window backer if required:
CO104 White Applique

Product Approval

As Is As Noted
 Approved By: _____
 Date: _____

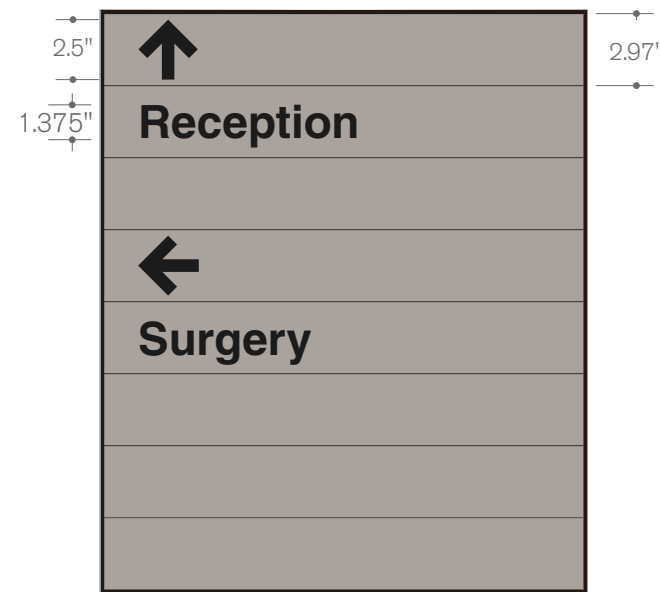

Type IN-14.01 Custom Magnetic + frame
 20"w X 3"h (Slat Size)(Qty 8)
 20.25"w X 24.25"h (Frame size)
with Frame

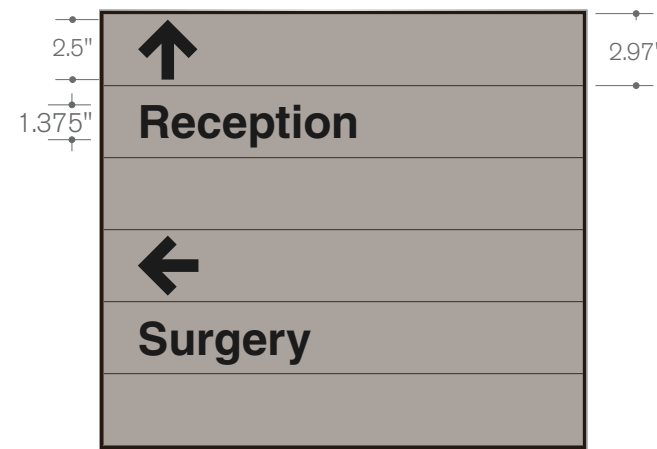

Type IN-14.04 Custom Magnetic + frame
 20"w X 3"h (Slat Size)(Qty 6)
 20.25"w X 18.25"h (Frame size)
with Frame

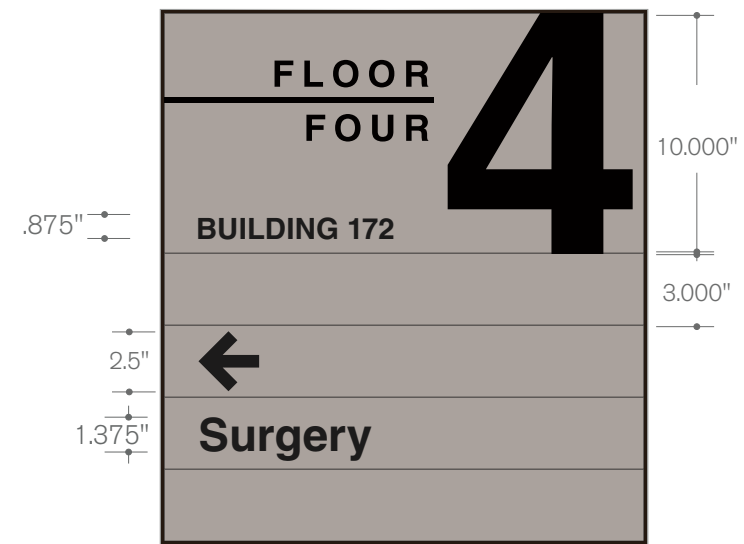

Type IN-14.11 Custom Magnetic + frame
 20"w X 3"h (Slat Size)(Qty 4)
 20"W X 10" (Header)(Qty 1)
 20.25"w X 22.25"h (Frame size)
with Frame

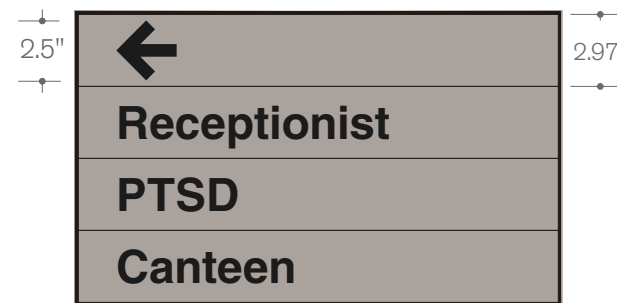

Type IN-14.05 Custom Magnetic + frame
 20"w X 3"h (Slat Size)(Qty 4)
 20.25"w X 12.25"h (Frame size)
with Frame

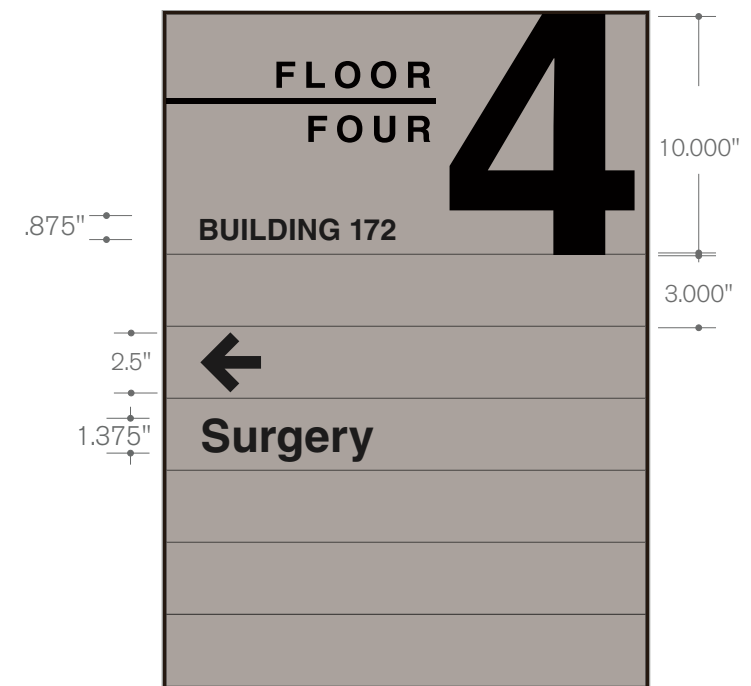

Type IN-14.12 Custom Magnetic + frame
 20"w X 3"h (Slat Size)(Qty 6)
 20"W X 10" (Header)(Qty 1)
 20.25"w X 28.25"h (Frame size)
with Frame

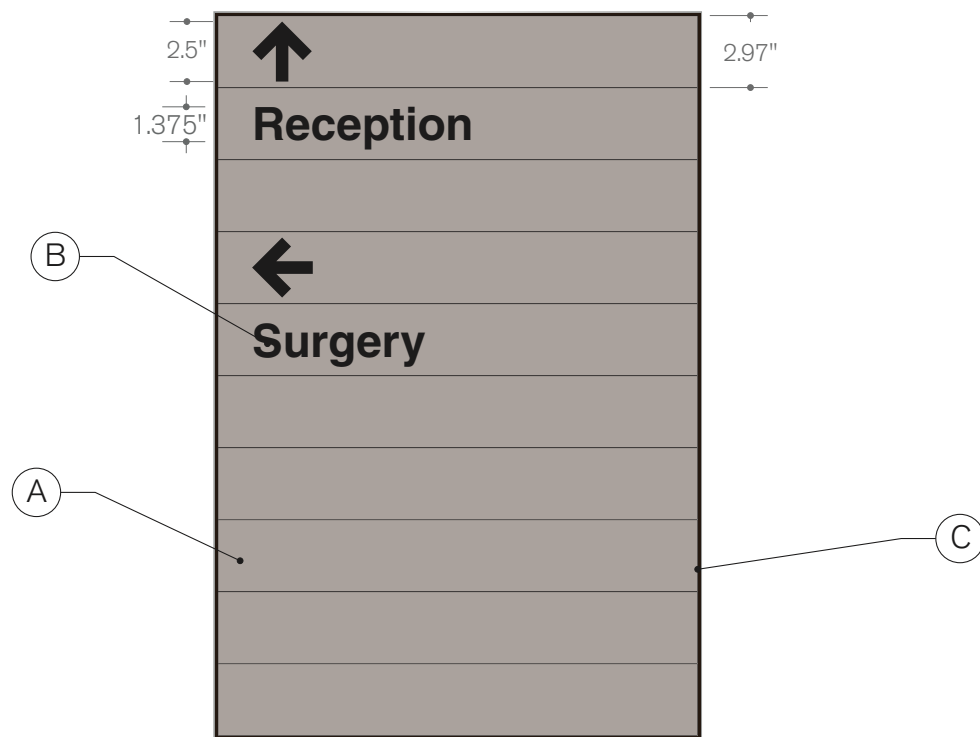

Type IN-14.02 Custom Magnetic + frame
 20"w X 3"h (Slat Size)(Qty 10)
 20.25"w X 30.25"h (Frame size)
with Frame

Direct Print Background

 (A) TKF Concrete

Direct Print Copy/Graphic

 (B) TKF Black
 Font Helvetica ADA/Helvetica Bold
 Helvetica Bold Condensed

Frame

 (C) JRS Frame #240

CONSTRUCTION NOTES (Refer to Engineering Drawings for additional details):

Header: .080 NG face 1/8" white acrylic w/ adhesive back, second surface printed, with surfaced applied applique and Braille
Center w/bezels: Magnetically Mounted, 080 NG face 1/8" white acrylic w/ adhesive back, second surface printed.
Frame: JRS Frame #240 outside 3/8 depth, included divider bar and inside metal, With matte black metal backer.

Rendering

Client:
Valiant Construction LLC

Project:
Marion IN VAMC
substitution samples

Date: 01.06.16 Drawn By: TW

Filename:
DEP0005_143436_RND_rev12

Design Review By:
FB

Revisions:
 02.24.16TW update layout
 04.21.16TW update category
 05.10.16 TW update MH signs
 06.13.16TW add signs
 07.18.16TW add signs
 07.28.16TW update headers
 08.05.16TW add signs
 08.11.16TW add signs
 08.25.16JLG add signs
 09.01.16TW add 14.11p
 09.02.16TW add IN15.52a

Wayfinding

- Notes:
- **Uppercase, brailled copy to be raised. All other copy, including pictograms, to be printed unless otherwise noted.**
 - Sign copy shown is for sample purposes only.
 - Window backer if required: CO104 White Applique

Product Approval

As Is As Noted
 Approved By: _____
 Date: _____



Type IN-16.51 CSA40X6+ Frame
 40"w X 6"h (Center Size)
 40.25"w X 6.25"h (Frame size)
4 mm ACM with Frame



Type IN-15.51 Custom Fusion Overhead
 40"w X 6"h
 Double sided suspended
.080 NG acrylic lens printed second surface *no paper insert*

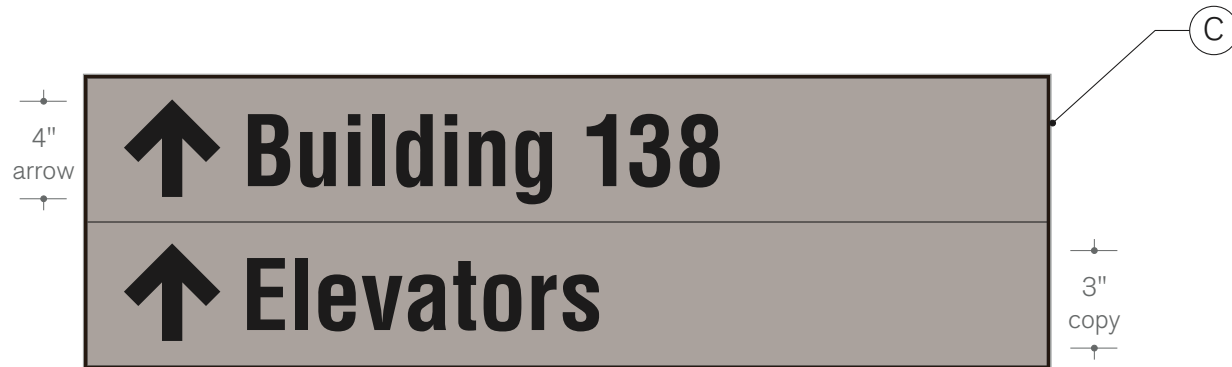

Type IN-16.52 CSA40X12+ Frame
 40"w X 12"h (Center Size)
 40.25"w X 12.25"h (Frame size)
4 mm ACM with Frame

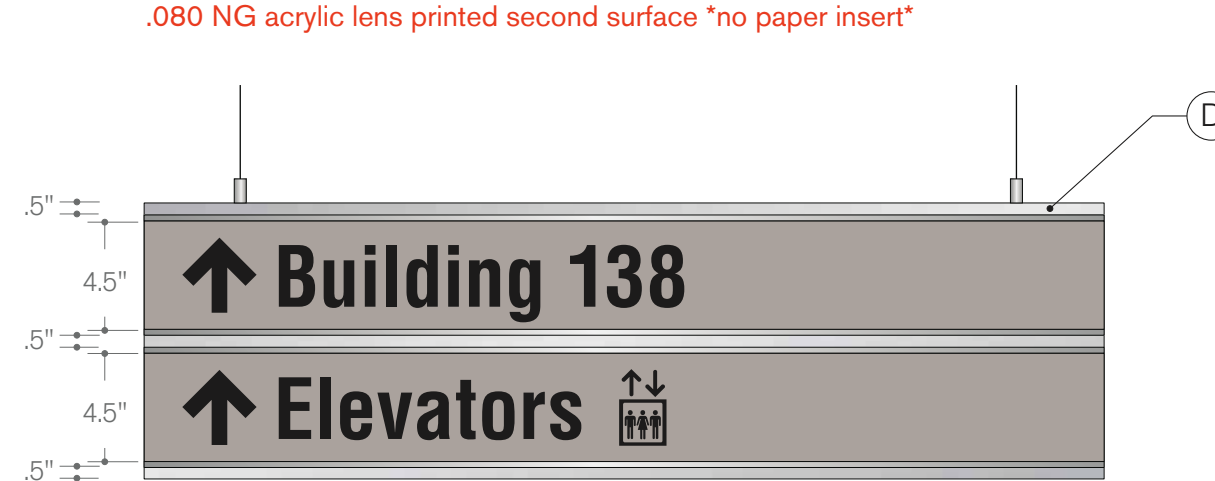

Type IN-15.52 Custom Fusion Overhead
 40"w X 11.5"h
 Double sided suspended
.080 NG acrylic lens printed second surface *no paper insert*

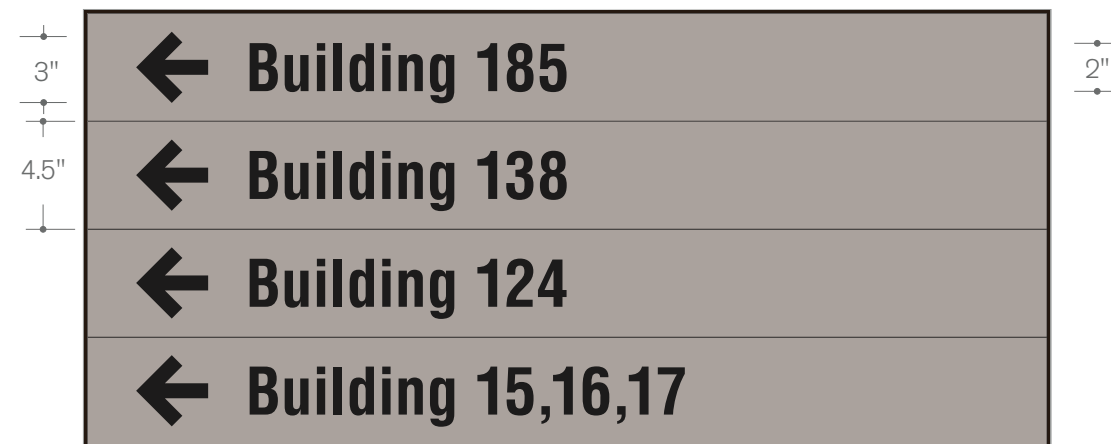

Type IN-16.53 CSA40X4.5 + Frame
 40"w X 4.5"h (Center Size)(Qty 4)
 40.25"w X 18.25"h (Frame size)
4 mm ACM with Frame



Type IN-15.52a Custom Fusion Overhead
 40"w X 11.5"h
 Double sided suspended
.080 NG acrylic lens printed second surface *no paper insert*

Direct Print Background



Direct Print Copy/Graphic

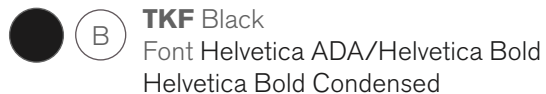

Frame



Finish



Rendering

Client:
Valiant Construction LLC

Project:
Marion IN VAMC
substitution samples

Date: 01.06.16 Drawn By: TW

Filename:
DEP0005_143436_RND_rev12

Design Review By:
FB

Revisions:
 02.24.16TW update layout
 04.21.16TW update category
 05.10.16 TW update MH signs
 06.13.16TW add signs
 07.18.16TW add signs
 07.28.16TW update headers
 08.05.16TW add signs
 08.11.16TW add signs
 08.25.16JLG add signs
 09.01.16TW add 14.11p
 09.02.16TW add IN15.52a

Wayfinding

- Notes:
- **Uppercase, brailled copy to be raised. All other copy, including pictograms, to be printed unless otherwise noted.**
 - Sign copy shown is for sample purposes only.
 - Window backer if required: CO104 White Applique

Product Approval

As Is As Noted

Approved By:

Date:



Type IN-16.51a Custom+ Frame
 40"w X 6"h (Center Size)
 40.25"w X 6.25"h (Frame size)
 .080 NG face
with Frame

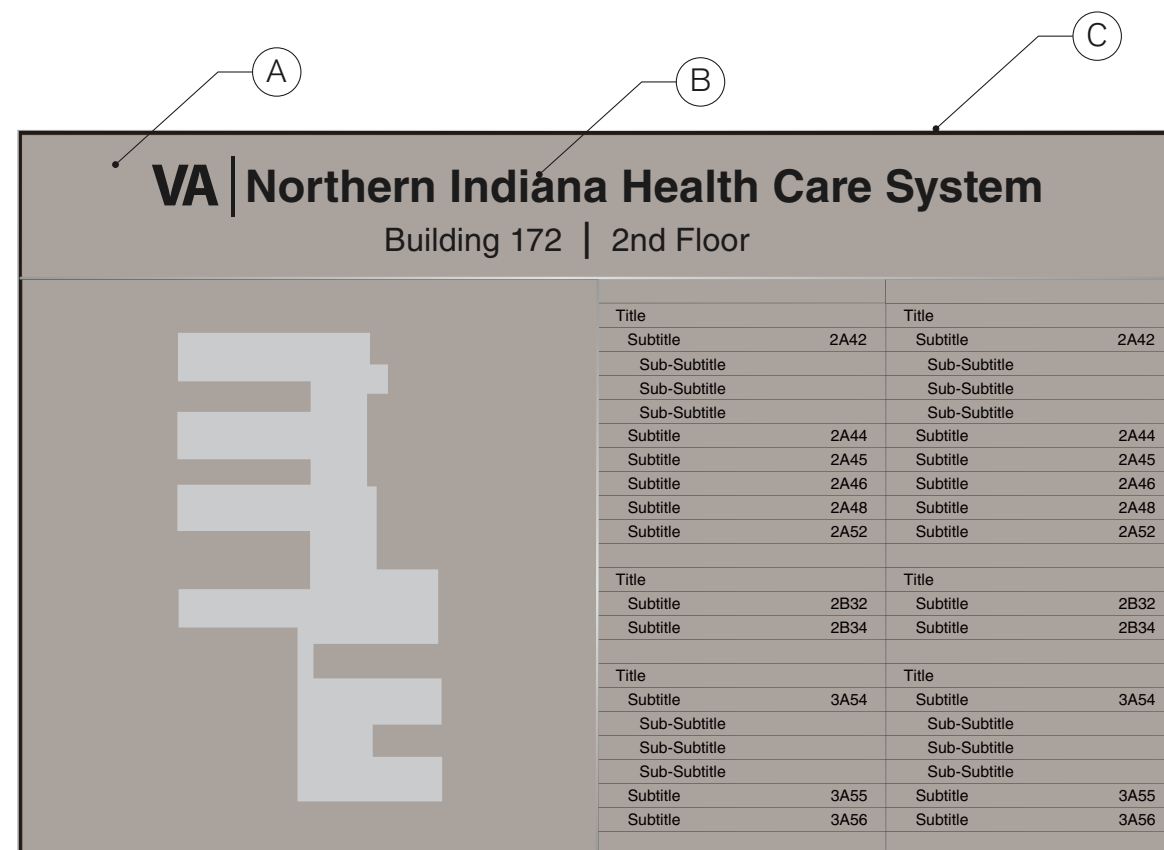

.060 NG face
 1/8" white acrylic
 w/ adhesive back

.060 NG face
 1/8" white acrylic
 w/ adhesive back
 Magnet mount

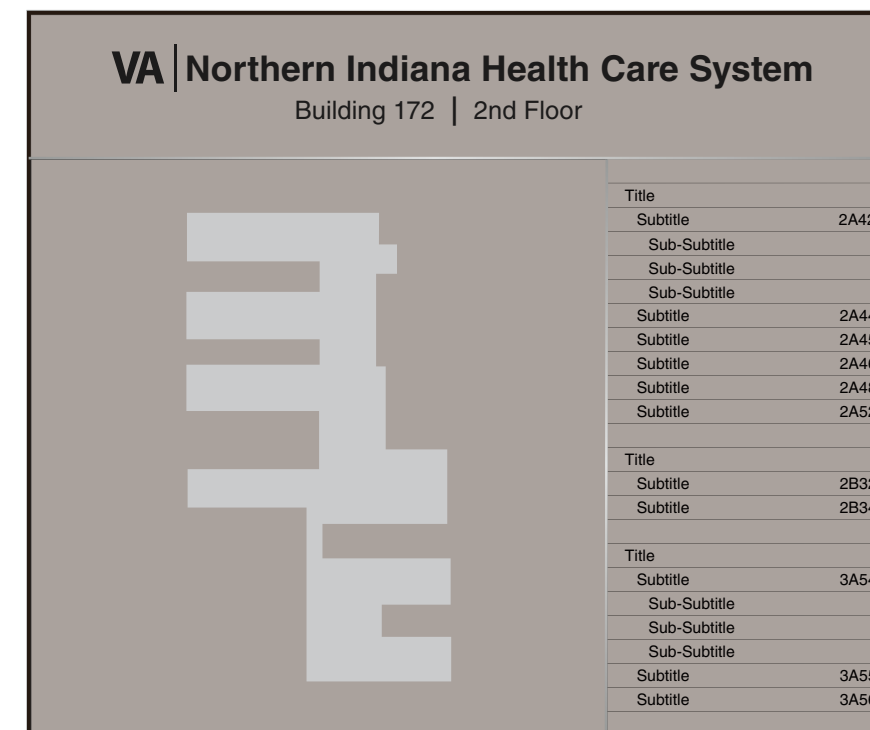

Type IN-17.03a Custom Magnetic + frame
 36"w X 6"h (Slat Size)(Qty 1)
 12"w X 1"h (Slat Size)(Qty 24)
 24"w X 24"h (Slat Size)(Qty 1)
 36.625"w X 30.625"h (Frame size)
with Frame

Type IN-17.03 Custom Magnetic + frame
 48.25"w X 6.125"h (Slat Size)(Qty 1)
 12"w X 1"h (Slat Size)(Qty 48)
 24"w X 24"h (Slat Size)(Qty 1)
 48.375"w X 30.625"h (Frame size)
with Frame

Direct Print Background



Frame



Direct Print Background



Direct Print Copy/Graphic



Direct Print Copy/Graphic



Rendering

Client:
Valiant Construction LLC

Project:
Marion IN VAMC
substitution samples

Date: 01.06.16 Drawn By: TW

Filename:
DEP0005_143436_RND_rev12

Design Review By:
FB

Revisions:
 02.24.16TW update layout
 04.21.16TW update category
 05.10.16 TW update MH signs
 06.13.16TW add signs
 07.18.16TW add signs
 07.28.16TW update headers
 08.05.16TW add signs
 08.11.16TW add signs
 08.25.16JLG add signs
 09.01.16TW add 14.11p
 09.02.16TW add IN15.52a

Wayfinding

- Notes:
- **Uppercase, brailled copy to be raised. All other copy, including pictograms, to be printed unless otherwise noted.**
 - Sign copy shown is for sample purposes only.
 - Window backer if required: CO104 White Applique

Product Approval

As Is As Noted
 Approved By:
 Date:

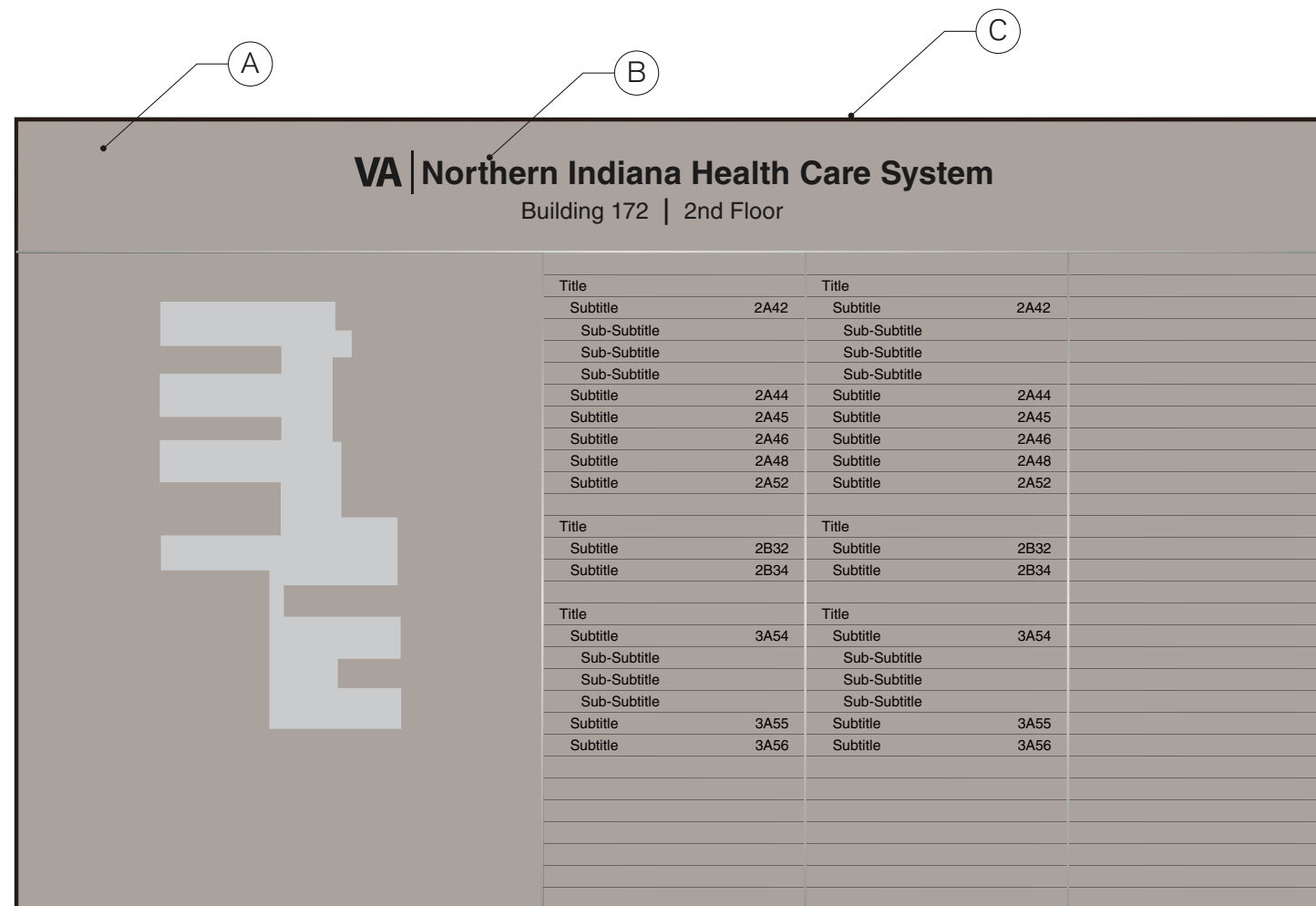

.060 NG face
1/8" white acrylic
w/ adhesive back

.060 NG face
1/8" white acrylic
w/ adhesive back
Magnet mount

Type IN-17.04 Custom Magnetic + frame
 60.3125"w X 6"h (Slat Size)(Qty 1)
 11.83"w X .995"h (Slat Size)(Qty 90)
 24"w X 30"h (Slat Size)(Qty 1)
 60.6875"w X 36.125"h (Frame size)
with Frame

Direct Print Background



Frame



Direct Print Copy/Graphic

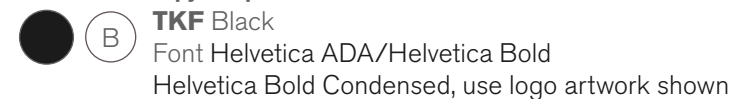

Rendering

Client:
Valiant Construction LLC

Project:
Marion IN VAMC
substitution samples

Date: 01.06.16 Drawn By: TW

Filename:
DEP0005_143436_RND_rev12

Design Review By:
FB

- Revisions:
- 02.24.16TW update layout
 - 04.21.16TW update category
 - 05.10.16 TW update MH signs
 - 06.13.16TW add signs
 - 07.18.16TW add signs
 - 07.28.16TW update headers
 - 08.05.16TW add signs
 - 08.11.16TW add signs
 - 08.25.16JLG add signs
 - 09.01.16TW add 14.11p
 - 09.02.16TW add IN15.52a

VA Required Signage

- Notes:
- **Uppercase, brailled copy to be raised. All other copy, including pictograms, to be printed unless otherwise noted.**
 - Sign copy shown is for sample purposes only.
 - Window backer if required: CO104 White Applique

Product Approval

As Is As Noted
 Approved By:
 Date:

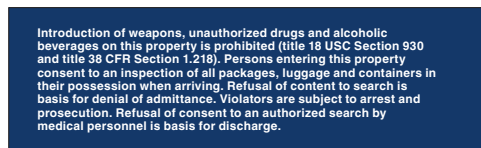

Type IN-02.01 CS20x6-T
20"w X 6"h
ACM

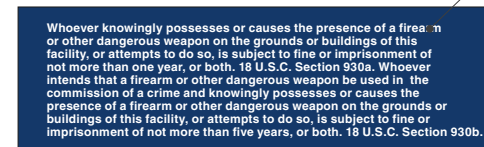

Type IN-02.03 CS20x6-T
20"w X 6"h
ACM

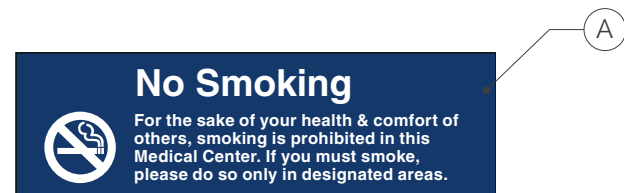

Type IN-02.02 CS20x6-T
20"w X 6"h
ACM





Type IN-02.10 CS20x6-T
20"w X 6"h
ACM

No Frames

Direct Print Background
 (A) **TKF 534**
 (to match Pantone 541)

Direct Print Background
 (B) **TKF White**

Direct Print Copy/Graphic
 (C) **TKF Black**
 Font Helvetica ADA/Helvetica Bold
 Helvetica Bold Condensed

Direct Print Copy/Graphic
 (D) **TKF Black, TKF 185**
 Font Helvetica ADA/Helvetica Bold

Direct Print Copy/Graphic
 (E) **TKF White**
 Font Helvetica ADA/Helvetica Bold
 Helvetica Bold Condensed

Rendering

Client:
Valiant Construction LLC

Project:
Marion IN VAMC
substitution samples

Date: 01.06.16 Drawn By: TW

Filename:
DEP0005_143436_RND_rev12

Design Review By:
FB

Revisions:
02.24.16TW update layout
04.21.16TW update category
05.10.16 TW update MH signs
06.13.16TW add signs
07.18.16TW add signs
07.28.16TW update headers
08.05.16TW add signs
08.11.16TW add signs
08.25.16JLG add signs
09.01.16TW add 14.11p
09.02.16TW add IN15.52a

Dimensional Letters

Scale: 1 1/2" = 1'

Notes:
▪ Client to verify mounting method

Product Approval

As Is As Noted
Approved By:
Date:



 **Painted Acrylic**
Finish on Face: PMS 541 C VA Blue
Finish on Edge: PMS 541 C VA Blue
Typeface: Helvetica Bold
Thickness: .375"
Mounting: Stud Flush

A

Rendering

Client:
Valiant Construction LLC

Project:
Marion IN VAMC
substitution samples

Date: 01.06.16 Drawn By: TW

Filename:
DEP0005_143436_RND_rev12

Design Review By:
FB

- Revisions:
- 02.24.16TW update layout
 - 04.21.16TW update catagory
 - 05.10.16 TW update MH signs
 - 06.13.16TW add signs
 - 07.18.16TW add signs
 - 07.28.16TW update headers
 - 08.05.16TW add signs
 - 08.11.16TW add signs
 - 08.25.16JLG add signs
 - 09.01.16TW add 14.11p
 - 09.02.16TW add IN15.52a

Mental Health

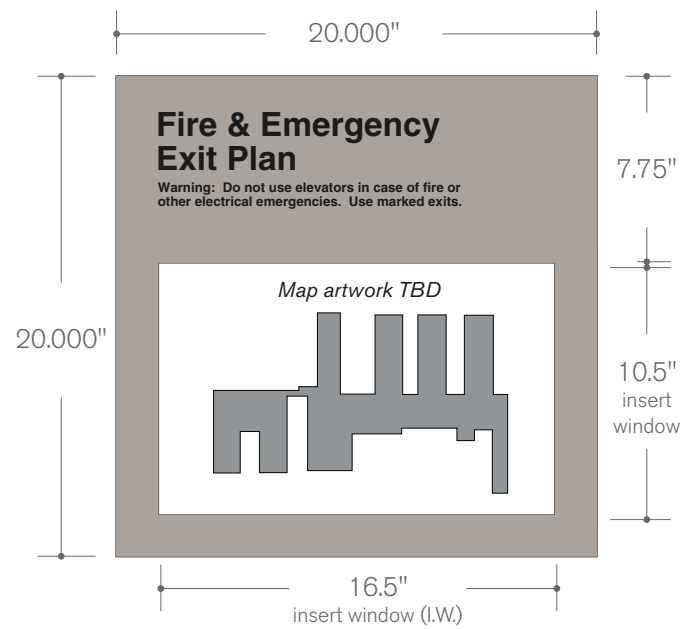

Type IN-01.01.01P Custom
20"w X 20"h
Accepts Insert

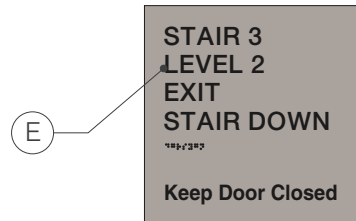

Type IN-01.10P Custom
9"w X 9"h

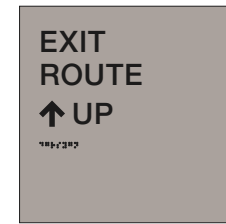

Type IN-01.29P Custom
9"w X 9"h



Type IN-09.03P Custom
9"w X 10.5"h



Type IN-01.11P Custom
18"w X 18"h

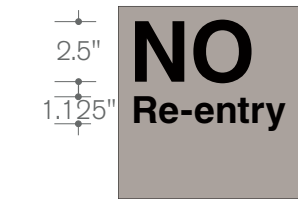

Type IN-01.30P Custom
9"w X 9"h

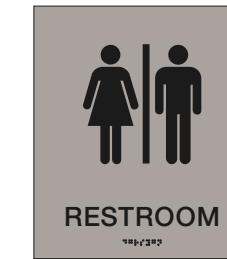

Type IN-09.06P Custom
9"w X 10.5"h



Type IN-01.05P Custom
9"w X 9"h



Type IN-01.06P Custom
9"w X 9"h

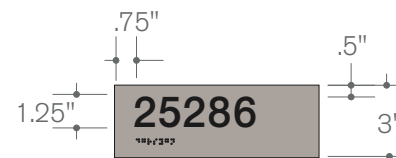

Type IN-03.01P Custom
8.5"w X 3"h
Accepts Insert

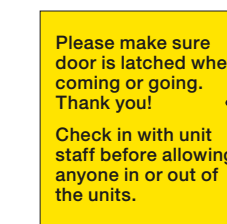

Type IN-01.16P Custom
9"w X 9"h

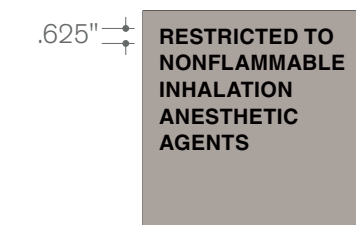

Type IN-01.18P Custom
9"w X 9"h

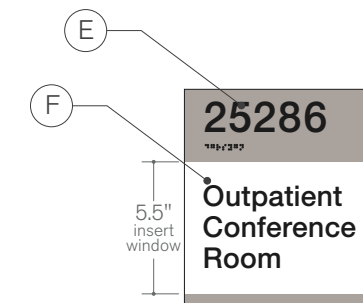

Type IN-04.03P Custom
8.5"w X 9"h
Accepts Insert



Type IN-01.27P Custom
9"w X 3"h

No Frames

All signs to be 1mm encapsulated single piece construction, square corners, with raised copy and domed grade II Braille.

Background (A) TKF Concrete	Direct Print Copy (C) White Font Helvetica ADA/Helvetica Bold	Raised Copy (E) Black Font Helvetica ADA	Direct Print Background (G) TKF 108 (to match OSHA Yellow)
Background (B) OSHA Red	Direct Print Copy (D) Black Font Helvetica ADA/Helvetica Bold Helvetica Bold Condensed	Insert (F) Media: White Paper; Font: Helvetica ADA, Helvetica Bold; Graphics/Copy Color: Black	

Product Approval

As Is As Noted
 Approved By: _____
 Date: _____

Rendering

Client:
Valiant Construction LLC

Project:
Marion IN VAMC
substitution samples

Date: 01.06.16 Drawn By: TW

Filename:
DEP0005_143436_RND_rev12

Design Review By:
FB

Revisions:
 02.24.16TW update layout
 04.21.16TW update category
 05.10.16 TW update MH signs
 06.13.16TW add signs
 07.18.16TW add signs
 07.28.16TW update headers
 08.05.16TW add signs
 08.11.16TW add signs
 08.25.16JLG add signs
 09.01.16TW add 14.11p
 09.02.16TW add IN15.52a

Mental Health

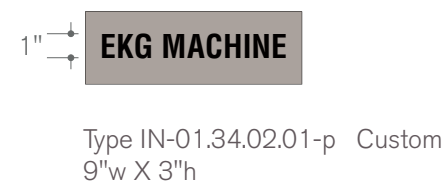
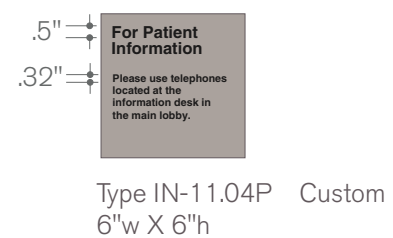
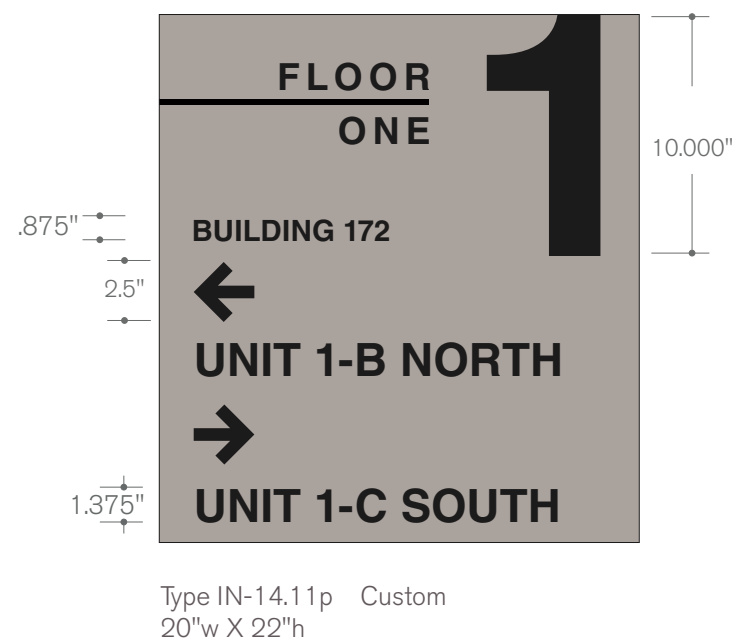
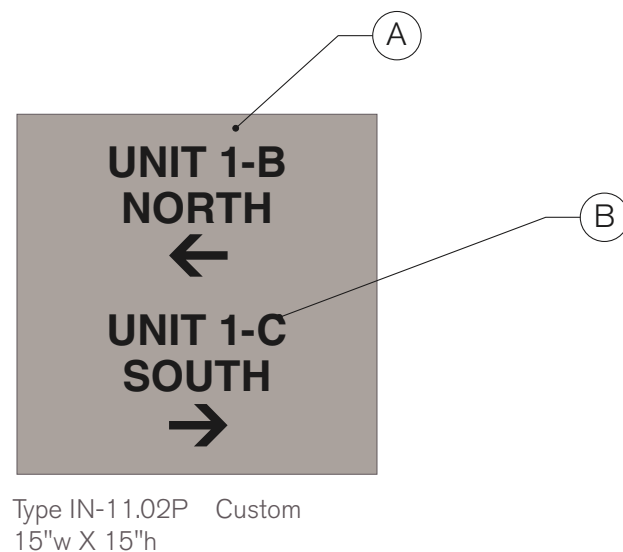
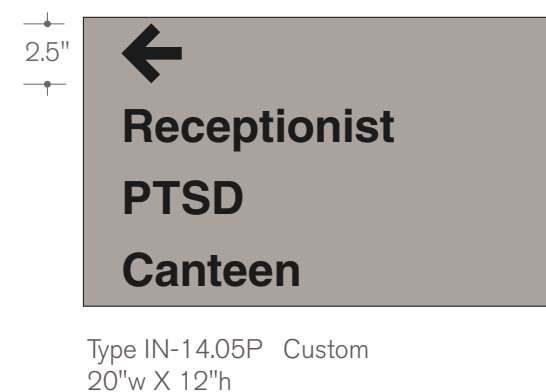
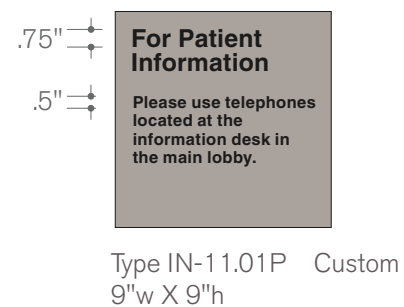

No Frames

All signs to be 1mm encapsulated single piece construction, square corners, with raised copy and domed grade II Braille.

Background



Direct Print Copy

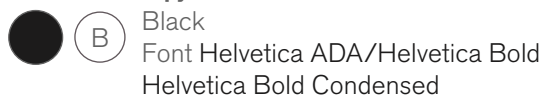

Product Approval

As Is As Noted
 Approved By: _____
 Date: _____