

**BY PDC - FOR REFERENCE ONLY**  
**FULLY SPRINKLED**

MRI	<b>Project Title:</b> <b>BUILDING 1 LEVEL 1 RENOVATE &amp; INSTALL MRI AREA</b>	<b>Date:</b> 6/15/2018	<b>VA</b> Department of Veterans Affairs
	<b>Building Number:</b> <b>1 - AREA E</b>	<b>Project No.</b> 589A5-CSI-301	
	<b>Location:</b> Colmery-O'Neil VA Medical Center, Topeka	<b>Checked By:</b> <b>AHT</b>	
	<b>Drawn By:</b> <b>JJG</b>	<b>Drawing No.</b> <b>1-AI-102</b>	Dwg. 41 Of 84

1

1

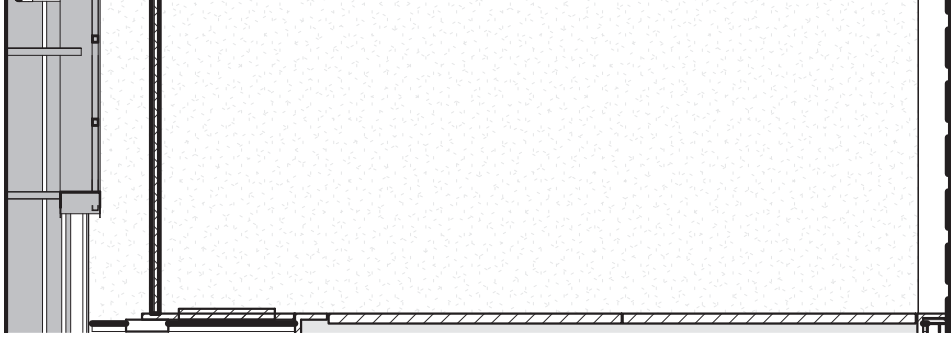
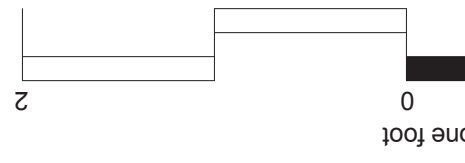
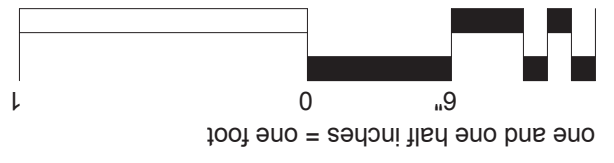
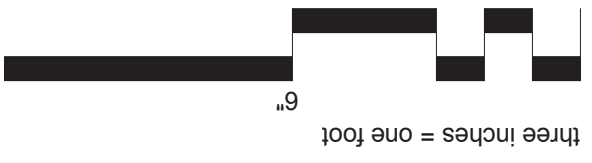

ALL MATERIALS AND PRODUCTS ARE SUBJECT TO REVIEW BY OWNER UNLESS OTHERWISE NOTED

## SCHEDULE - MRI AREA

ITEM	WALLS		CEILING		Comments
	SOUTH	WEST	MATERIAL	FINISH	
	P-1	P-2	EX	EX	
	P-1	P-1	EX	EX	
	P-1	P-1	EX	EX	TILE FROM TOP OF BASE TO 6'6" AFF; RE: ELEVATIONS
	P-1	P-1	AT	AT-1	BY PREFAB MRI BLDG SUPPLIER
	P-1	P-1	AT	AT-1	BY PREFAB MRI BLDG SUPPLIER
	P-1	P-1	GWB	PT-5	BY PREFAB MRI BLDG SUPPLIER
	EX	EX	GWB	P-1	LEVEL 2 FINISH

### FULLY SPRINKLED

<b>PROJECT TITLE:</b> <b>BUILDING 1 LEVEL 1                  RENOVATE &amp; INSTALL                  MRI AREA</b>	<b>DATE:</b> 6/15/2018		
	<b>BUILDING NUMBER:</b> <b>1 - AREA E</b>		<b>PROJECT NO.:</b> 589A5-CSI-301
	<b>CHECKED BY:</b> <b>AHT</b>		<b>DRAWING NO.:</b> <b>1-AI-104</b>  Dwg. 43 Of 84
<b>LOCATION:</b> Colmery-O'Neil VA Medical Center, Topeka			

1

1

1

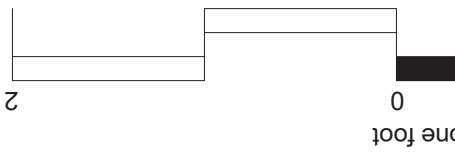
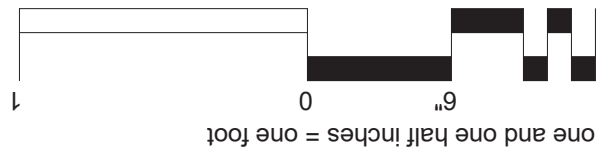
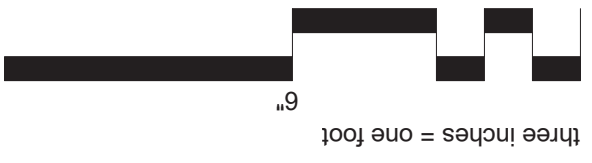

1

1

1

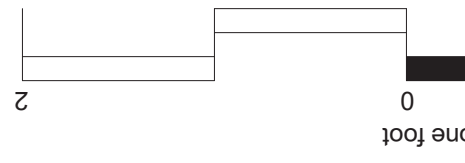
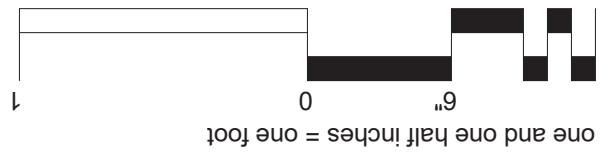
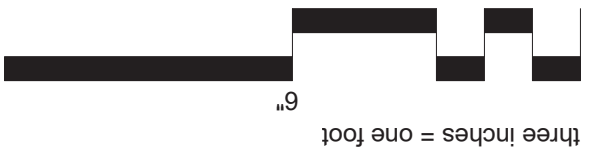

1

1

1

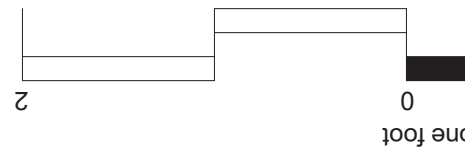
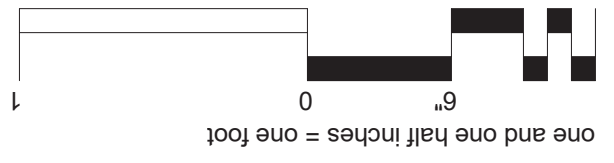
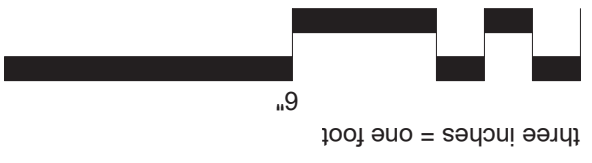

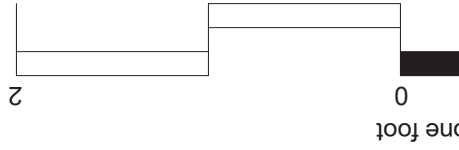
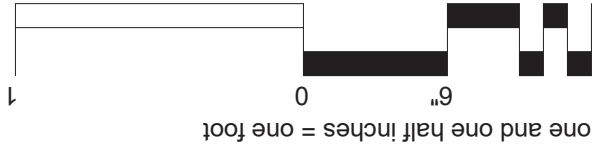
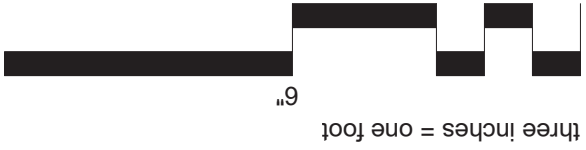

1

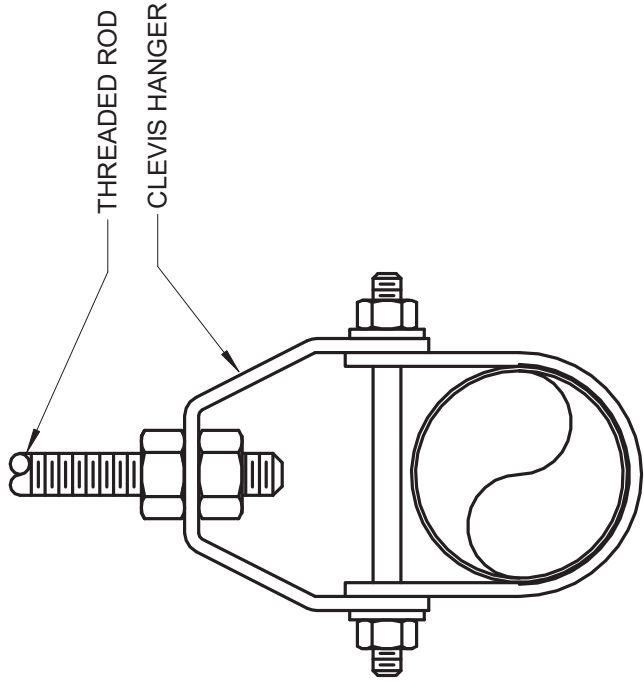

CLEVIS HANGER

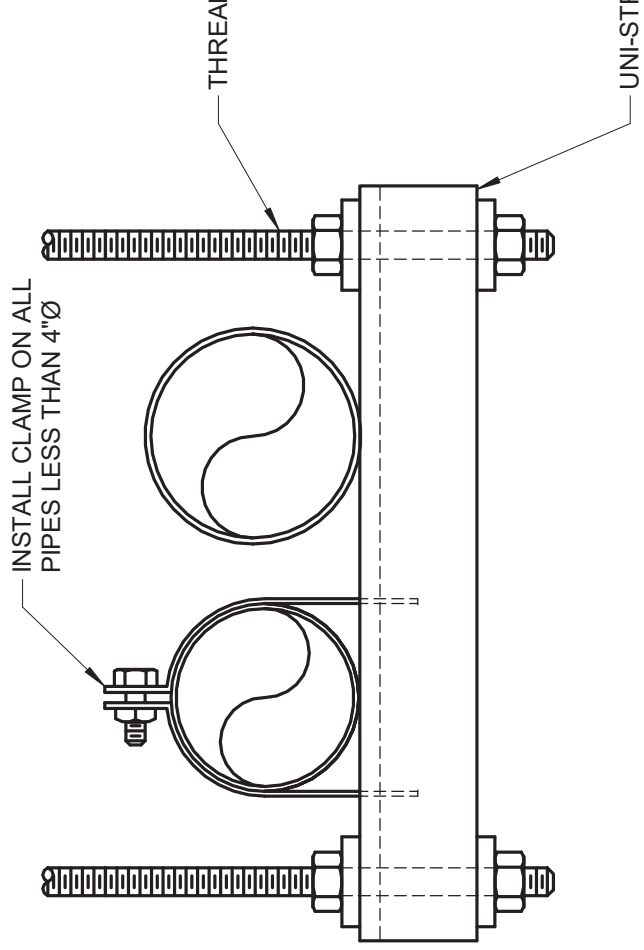

TRAPEZE HANGER

1

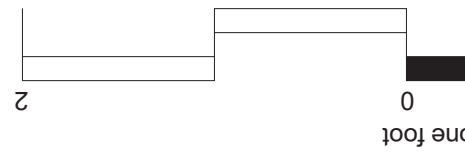
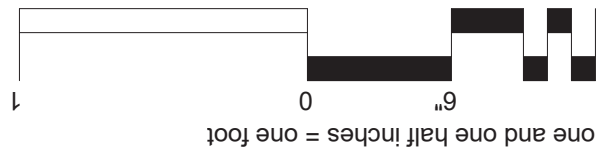
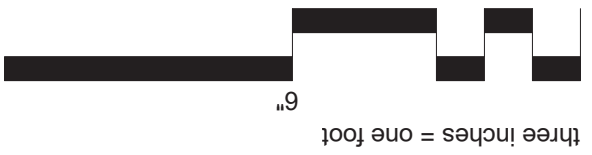

NAME  
10' - 0"

LEVEL N  
HEIGHT  
PROJECT



LINE TYPE KEY:

- \_\_\_\_\_ NEW WORK B (DARK SOLID)
- NEW WORK U (DARK LONG DASH)
- \_\_\_\_\_ NEW WORK B (LIGHT SOLID)
- EXISTING TO B (DARK SHORT DASH)

**CONTRACT**

ABBR:	DESCRIPTION:
C.C.	CIVIL CONTRACT
E.C.	ELECTRICAL CONTRACT
F.P.C.	FIRE PROTECTION
G.C.	GENERAL CONTRACT
M.C.	MECHANICAL CONTRACT



1

1

1

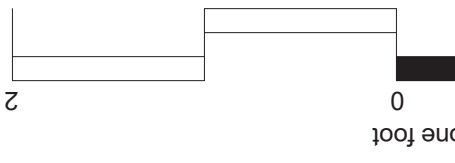
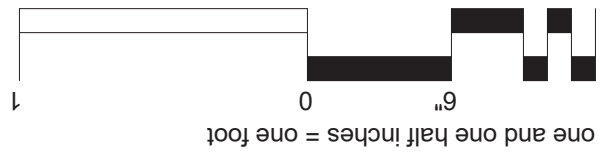
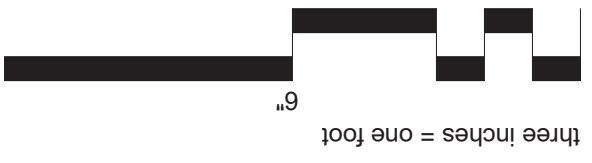

1

1

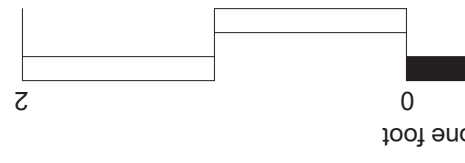
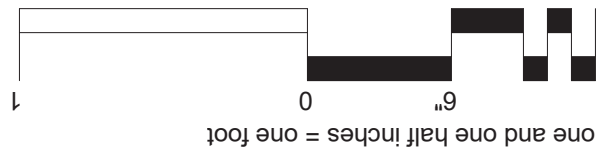
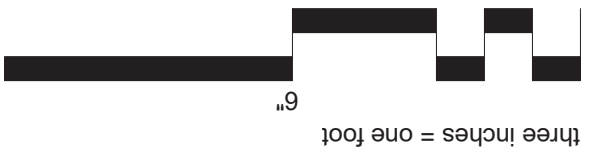

1

0

2

0

1

1

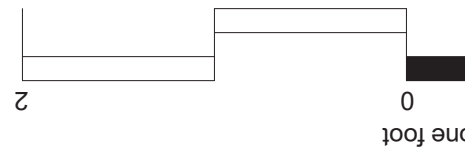
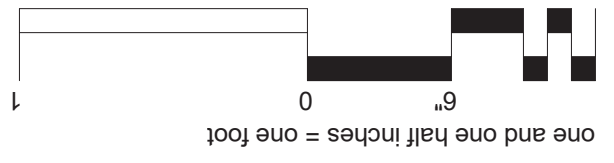
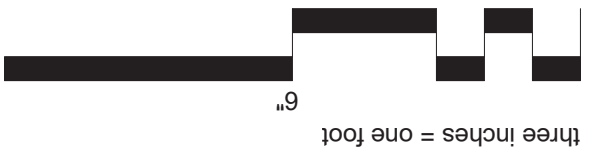

1

1

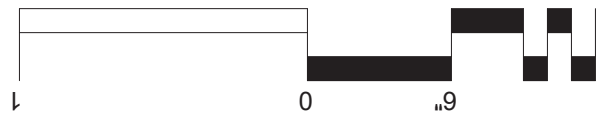
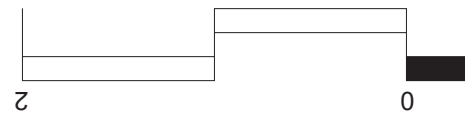
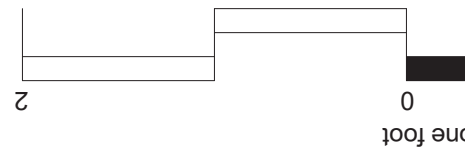
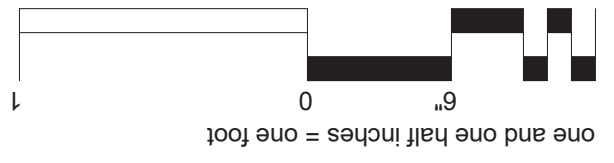
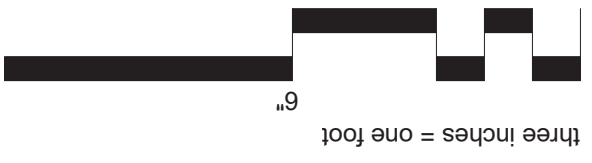

1

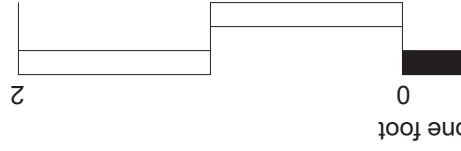
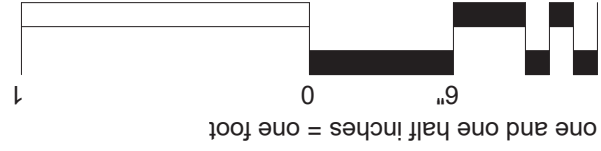
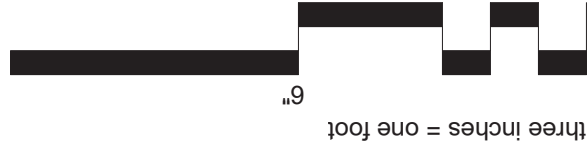

COMPOSITION FLOORING  
 ADJUSTABLE NICKEL BRONZE STRAINER WITH 4" FLANGE (FLUSH WITH FINISHED FLOOR)

LOOSE GRAVEL AT WEEP HOLES TO GRAVEL SIZE

INVERTIBLE FLASHING COLLAR

WEEP HOLES

CAULKED, NON-THREADED CONNECTION

1

TYPE "D" FLOOR

NO SCALE

—

1

—

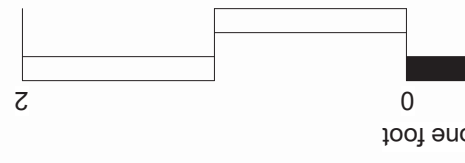
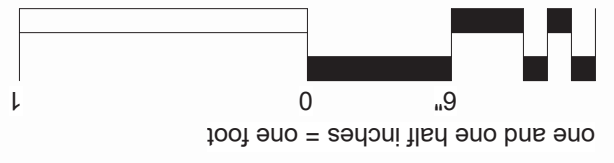
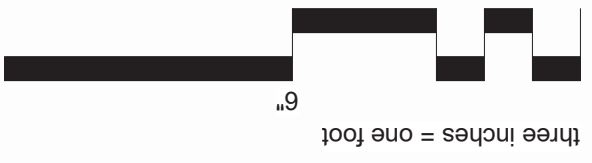

one foot

1

1

1

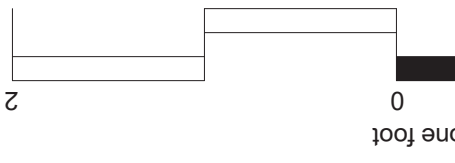
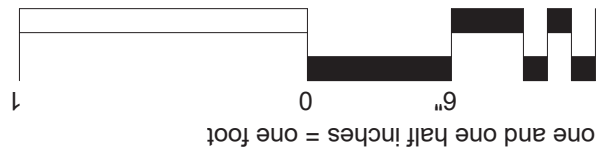
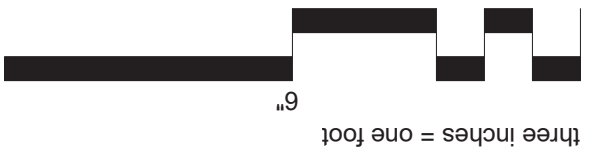

# VIEW KEY

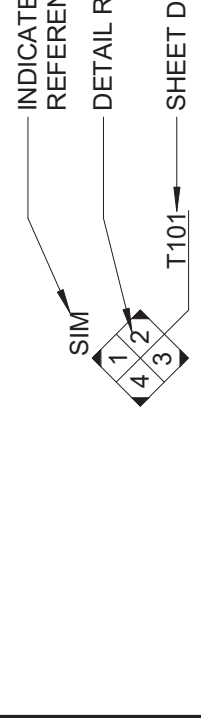
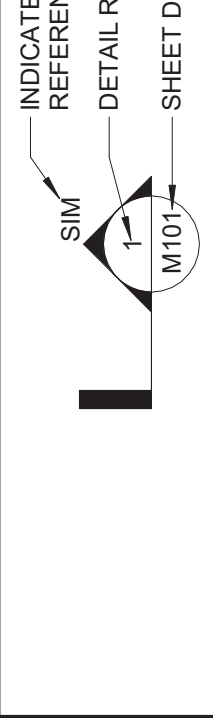
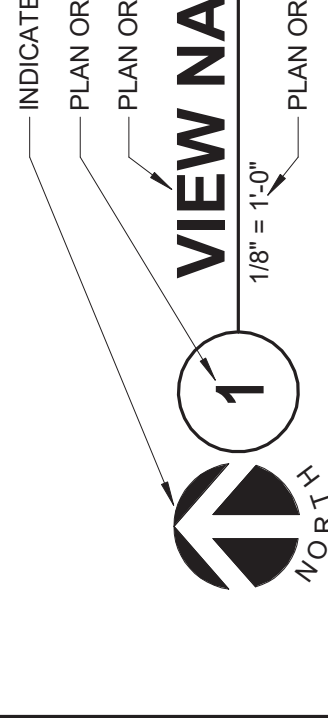

**LINE TYPE KEY:**

- NEW WORK BY THIS CONTRACTOR (DARK SOLID LINE)
- - - - NEW WORK UNDERFLOOR OR UNDER (DARK LONG DASHED LINE)
- NEW WORK BY OTHERS AND/OR EXIST (LIGHT SOLID LINE)
- - - - EXISTING TO BE REMOVED BY THIS CONTRACTOR (DARK SHORT DASHED LINE)

# CONTRACTOR ABBREVIATIONS

ABBR:	DESCRIPTION:
C.C.	CIVIL CONTRACTOR
E.C.	ELECTRICAL CONTRACTOR
F.P.C.	FIRE PROTECTION CONTRACTOR
G.C.	GENERAL CONTRACTOR
M.C.	MECHANICAL CONTRACTOR

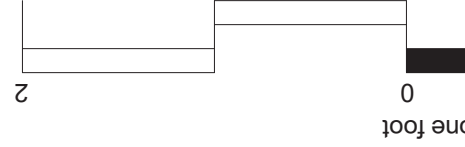
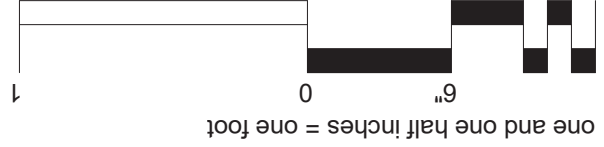
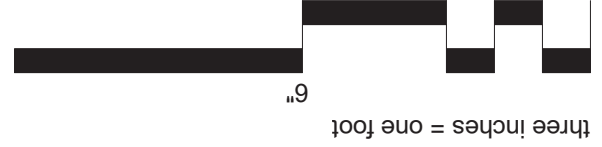



1

1

1

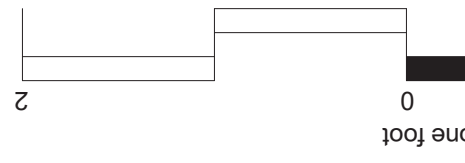
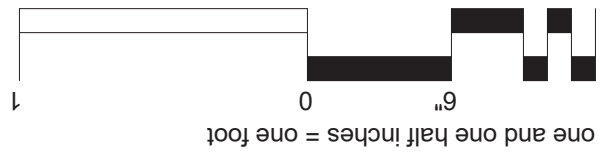
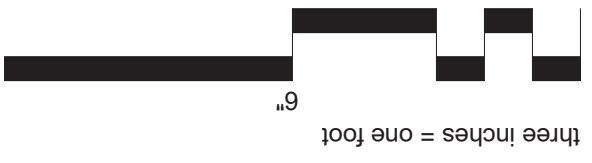

one foot



1

1

1

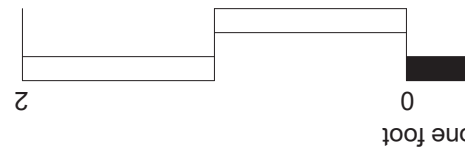
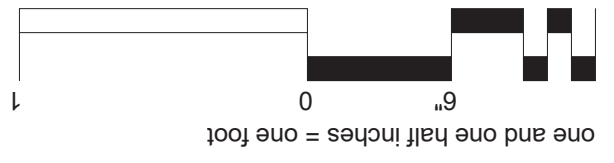
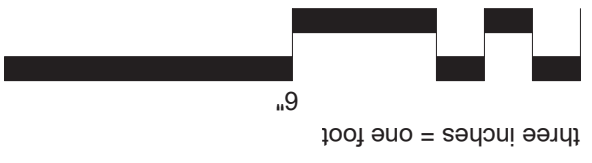

1

1

1

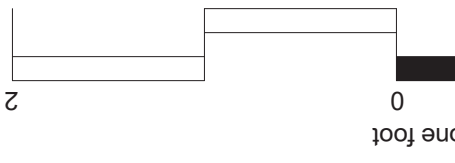
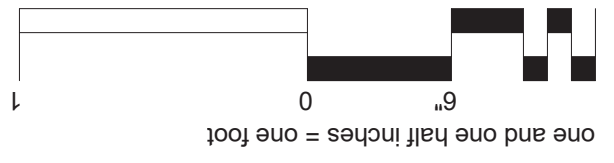
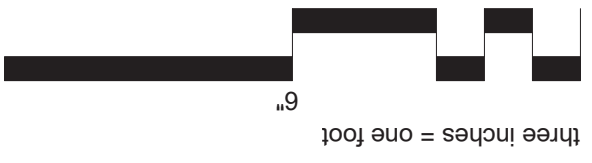

1

1

1

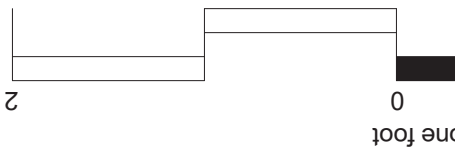
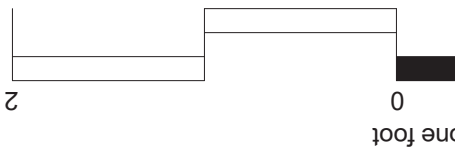
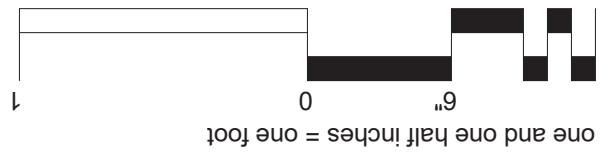
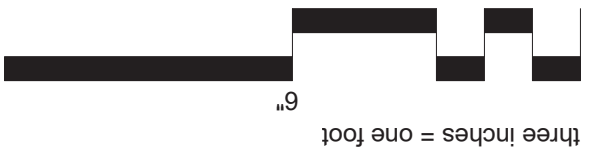

1

1

1

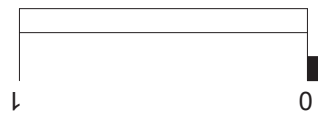
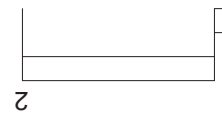
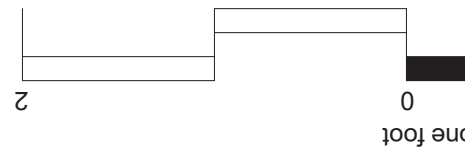
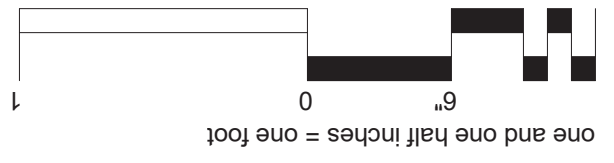
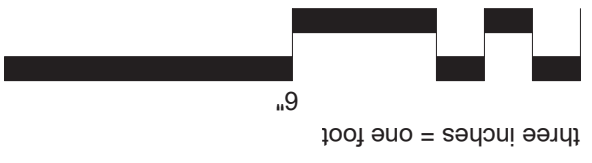

1

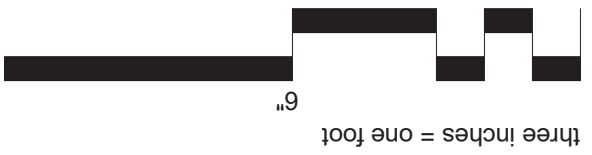

HANGER ROD

INSULATION (VAPOR BARRIER TYPE IS REQUIRED FOR LOW TEMPERATURE PIPE)

PROVIDE HIGH COM STRENGTH INSULAT PSF (MIN. DENSITY) UNDER INSULATION SHIELD

INSULATION SHIELD AT HANGER

ADJUSTABLE CLEVIS HANGER TYPE 1 -  
SEE SPECIFICATIONS

PROVIDE INSULATION SHIELD & INSERT FOR ALL PIPING (200mm [8"] MIN.)

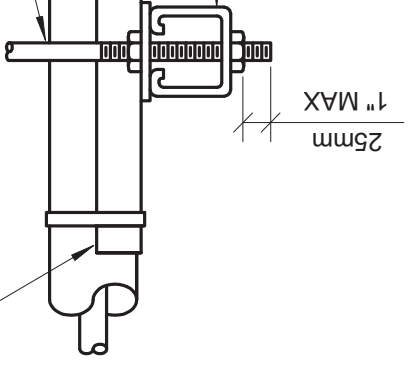

1" MAX  
25mm

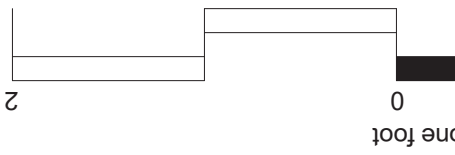

SIDE VIEW TRAPEZE HANGER TYPE 1 -  
453KG [1000 LB.] UNIFORM LOAD

**1** PIPE HANGER  
NO SCALE

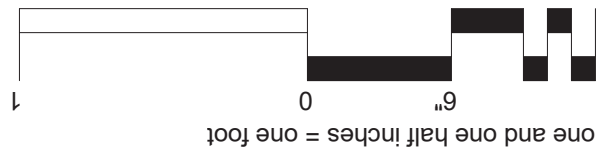

one and one half inches = one foot

one foot

three inches = one foot

6"

6"

0

2

1

0

0

1

1

1

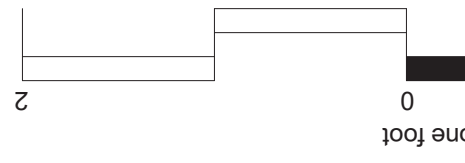
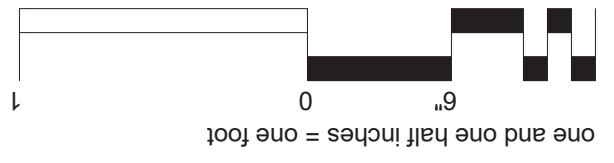
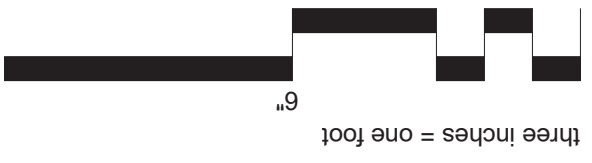



1

1

1

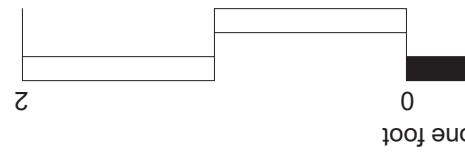
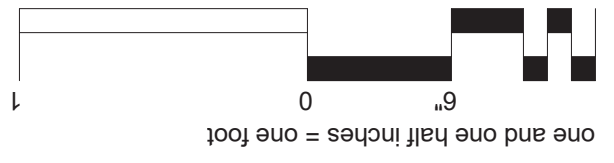
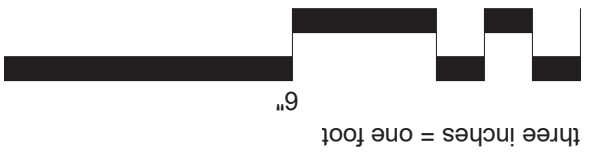

1

1

1

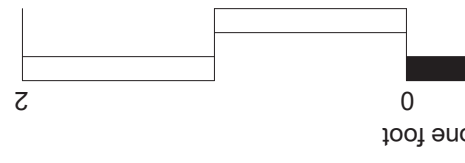
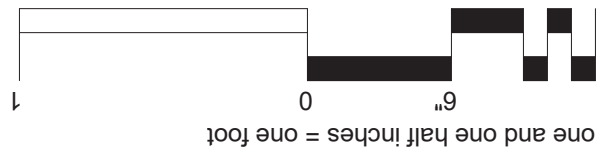
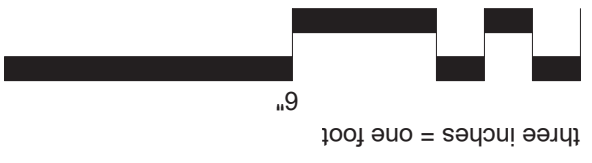

# ELECT

SYMBOL:



\$2

1

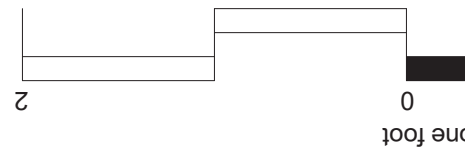
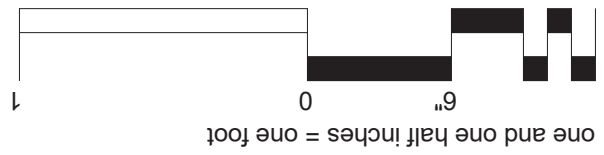
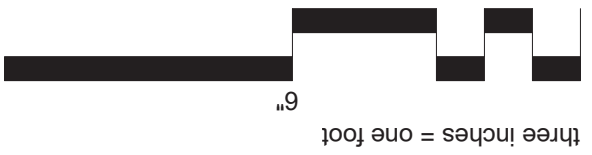

1

1

1

